

UCC T3 installation guide

www.renishaw.com

UCC T3 installation guide

Document part number H-1000-7578-02-A



UCC T3 installation guide

www.renishaw.com

General information

© 2012 - 2013 Renishaw plc. All rights reserved.

This document may not be copied or reproduced in whole or in part, or transferred to any other media or language, by any means, without the prior written permission of Renishaw.

The publication of material within this document does not imply freedom from the patent rights of Renishaw plc.

Disclaimer

RENISHAW HAS MADE CONSIDERABLE EFFORTS TO ENSURE THE CONTENT OF THIS DOCUMENT IS CORRECT AT THE DATE OF PUBLICATION BUT MAKES NO WARRANTIES OR REPRESENTATIONS REGARDING THE CONTENT. RENISHAW EXCLUDES LIABILITY, HOWSOEVER ARISING, FOR ANY INACCURACIES IN THIS DOCUMENT.

Trademarks

RENISHAW® and the probe emblem used in the **RENISHAW** logo are registered trademarks of Renishaw plc in the UK and other countries.

apply innovation is a trademark of Renishaw plc.

All brand names and product names used in this document are trade names, service marks, trademarks, or registered trademarks of their respective owners.

Windows XP, Windows 2000, Vista, Windows 7 and Windows 10 are registered trade names of the Microsoft Corporation.

All trademarks and trade names are acknowledged.

WEEE



The use of this symbol on Renishaw products and/or accompanying documentation indicates that the product should not be mixed with the general household waste upon disposal. It is the responsibility of the end user to dispose of this product at a designated collection point for waste electrical and electronic equipment (WEEE) to enable reuse or recycling. Correct disposal of this product will help save valuable resources and prevent potential negative effects on the environment. For more information, please contact your local waste disposal service or Renishaw distributor.

Warranty

Renishaw plc warrants its equipment for a limited period (as set out in our Standard Terms and Conditions of Sale) provided that it is installed exactly as defined in associated Renishaw documentation.

Prior consent must be obtained from Renishaw if non-Renishaw equipment (e.g. interfaces and/or cabling) is to be used or substituted. Failure to comply with this will invalidate the Renishaw warranty.

Claims under warranty must be made from authorised service centres only, which may be advised by the supplier or distributor.

UCC T3 installation guide

www.renishaw.com

Care of equipment

Renishaw probes and associated systems are precision tools used for obtaining precise measurements and must therefore be treated with care.

Changes to Renishaw products

Renishaw reserves the right to improve, change or modify its hardware or software without incurring any obligations to make changes to Renishaw equipment previously sold.

UCC T3 installation guide

www.renishaw.com

EC declaration of conformity

Renishaw plc hereby declare that the UCC T3 controller is in compliance with the relevant provisions of directives 2004/108/EC and 2006/95/EC.

Contact Renishaw plc or visit www.renishaw.com/knowledgebase for the full EU declaration.

UCC T3 installation guide

www.renishaw.com

FCC (USA only)

Information to user (47CFR section 15.105)

This equipment has been tested and found to comply with the limits for a Class A digital device, pursuant to Part 15 of the FCC rules. These limits are designed to provide reasonable protection against harmful interference when the equipment is operated in a commercial environment. This equipment generates, uses, and can radiate radio frequency energy and, if not installed and used in accordance with the instruction manual, may cause harmful interference to radio communications. Operation of this equipment in a residential area is likely to cause harmful interference, in which case you will be required to correct the interference at your own expense.

Information to user (47CFR section 15.21)

The user is cautioned that any changes or modifications not expressly approved by Renishaw plc or an authorised representative could void the user's authority to operate the equipment.

UCC T3 installation guide

www.renishaw.com

Safety



WARNING: Earthing provision for the complete machine is the responsibility of the OEM or installer.



WARNING: Isolation: UCC T3 is isolated from the dc power supply by disconnection of the power connector. If any additional means of isolation is required, it must be specified and fitted by the machine manufacturer or the installer of the product. The isolator must be sited within easy reach of the CMM operator and comply with IEC61010 and any applicable national wiring regulations for the country of installation.



WARNING: The PSU must be single fault tolerant, approved to EN60950-1 and must be connected to a supply incorporating a protective earth conductor. Earthing provisions and residual fault protection for the complete machine are the responsibility of the OEM or installer.

Machine safety



WARNING: Switching off or isolating the UCC T3 may NOT prevent unexpected machine movement. The user is advised to isolate the machine from the electricity supply, compressed air or other energy sources in accordance with the machine manufacturer's instructions before entering the danger zone or performing any maintenance operations.

If the equipment is used in a manner not specified by the manufacturer, the protection provided by the equipment may be impaired.

The emergency stop safety system that has been integrated into the UCC T3 controller is designed to achieve category 2 to standard BS EN ISO13849-1:2008, this can be hardware configured to obtain category B. The risk assessment made by the system installer on the installation should therefore have determined which category is required.

The UCC T3 must only be commissioned through Renishaw software, failure to do so may result in unexpected machine movement.

UCC T3 installation guide

www.renishaw.com

Environmental conditions

Indoor use	IP30* (BS EN60529:1992)
Altitude	Up to 2000 m
Operating temperature	+5 °C to +50 °C
Storage temperature	-25 °C to +70 °C
Relative humidity	80% maximum (non-condensing) for temperatures up to +31 °C Linear decrease to 50% at +40 °C
Transient voltages	Installation category II
Pollution degree	2



* **NOTE:** It may be necessary to house UCC T3 in a suitable electrical enclosure according to the installation's environmental conditions to obtain a higher IP rating.



NOTE: For ambient temperatures under 40 °C, maximum input power for the UCC T3 is 800 W. For temperatures between 40 °C and 50 °C the maximum power is 400 W.



WARNING: UCC T3 is not recommended for use in ambient temperatures above 50 °C.

UCC T3 installation guide

www.renishaw.com

References and associated documents

Please use the following link for all Renishaw documentation:

www.renishaw.com/cmmguides

UCC T3 installation guide

www.renishaw.com

System overview

UCC T3 is an addition to the Renishaw CMM controller product range. UCC T3 combines the control capabilities of UCCLite-2 with the servo power amplifier performance of the SPALite, with enhancements for higher power and category 2 E-STOP.

The high power capability combined with the compact form of the UCC T3 controller-amplifier enables use across a wide range of machines.

The complete range of Renishaw two-wire kinematic touch-trigger probes is supported. Conventional contact and strain-gauge sensors and manual and motorised probe heads with appropriate probe or stylus changers are supported only with additional hardware (for example a PH10 PLUS head will need a PHC10-3 PLUS which will be connected to the serial comms port on the controller).

The UCC T3 CMM controller-amplifier has the following capabilities:

- Controls three axes of a CMM
- Accepts input signals from air pressure sensors, crash detectors and all axis inner and outer travel limit switches
- Accepts two uncommitted general-purpose input signals and generates one uncommitted general-purpose output signal
- Serial communication for use with a Renishaw PHC10-3 PLUS controller
- Directly supports the TP1, TP2, TP6, TP20 touch-trigger probes
- Indirectly supports the TP200 via an external PI 200-3 interface
- Provides a +24 V supply for use by the CMM switches
- Supports the MCULite-2 joystick (it can also support the MCU5 and MCU W)
- Provides power output of up to 800 W continuous and 960 W for up to 1 second
- The voltage setting of each axis is independent, allowing differing motor voltages to be used without damage
- Supports dc motors in the range 24 V to 80 V, currents up to 10 A
- Supports encoder / tachometer or linear encoders (torque mode) for velocity feedback
- Simulated linear power amplifier - drive outputs are free from switching edges, eliminating noise from drive PWM improving repeatability and reducing emissions
- Provides category 2 E-STOP

UCC T3 installation guide

www.renishaw.com

System features

The unit has the following facilities:

- Rear panel connectors for the external interface cables to and from the CMM
- Rear panel USB connection for the two-way communication link to the CMM host computer
- Rear panel connection for a Renishaw MCU joystick
- Readhead circuitry for CMM digital measuring scales and motor encoders
- Digital servo power amplifier
- Status-indicating LEDs
- Control electronics for probes and peripheral devices attached to the CMM
- LEDs visible through the front panel of the UCC T3 enclosure indicate the operational status

Sub-circuits in the unit control the following interfaces through connectors on the rear panel of the enclosure:

- USB data link to the CMM host computer
- X, Y, Z axis data input from the CMM readheads
- Motor drives
- Connections for the TP20, TP1, TP2 and TP6 touch-trigger probes
- I/O connections to limit switches, air pressure sensors and other digital inputs and outputs

UCC T3 installation guide

www.renishaw.com

System components

The part numbers of the UCC T3 kits and upgrades are:

UCC T3 kits

A-5518-0001 - UCC T3 controller-amplifier

A-5518-0501 - UCC T3 controller-amplifier kit 1 comprising:

- A-5518-0001 - UCC T3 controller-amplifier kit
- A-5331-0007 - MCULite-2 joystick

A-5518-0020 - UCC T3 controller-amplifier kit 2 comprising:

- A-5518-0001 - UCC T3 controller-amplifier kit
- A-5331-0007 - MCULite-2 joystick
- A-5518-0025 - PSU 600 W 60 V + cable (medium / large machines)

UCC T3 accessories

A-5518-0005 - UCC T3 bracket kit

A-5518-0010 - UCC T3 connector kit (including USB cable)

A-5518-0011 - UCC T3 filter replacement kit

P-EA02-0021 - PSU 70 W 24 V (small machines)

A-5518-0025 - PSU 600 W 60 V + cable (medium / large machines)

A-5331-0007 - MCULite-2 joystick

A-5121-0003 - MCU 5 joystick

A-5863-0100 - PHC10-3 PLUS head controller

A-5567-1622 - PHC10-3 RS232 comms cable

A-5707-0100 - PI 200-3 probe interface

UCC T3 installation guide

www.renishaw.com

Installation software

UCCassist-2

The Renishaw UCCassist-2 program is a utility to assist the engineer to install, commission and maintain a CMM system based on the UCC T3 controller-amplifier.

Capabilities of the software include:

- Basic machine system diagnostics
- Operation with Renishaw's machine checking gauge, enabling the user to complete frequent volumetric accuracy tests to ensure the CMM is running within the specified operational tolerances
- Automated CMM error-mapping routines, when used in conjunction with the Renishaw ML10 or XL80 laser systems

UCC T3 installation guide

www.renishaw.com

CMM host computer for UCC T3 controller installation

For the installation of a UCC T3 controller, the CMM host computer must use Windows XP Pro, Windows Vista or Windows 7 as an operating system and a hard disc drive with available storage space of at least 300 Mbytes. The processor speed and RAM requirements are not excessive - if the PC supports the operating system and application software, it will almost certainly support the UCC controller operation. A minimum specification of 1 GHz processor speed and 256 Mbytes RAM is recommended but please check with your application software vendor for their requirements, as they may be higher.

UCC T3 installation guide

www.renishaw.com

General wiring standards for UCC T3 controller installation

To achieve reliable operation of the UCC T3 and the CMM host computer, the following should be observed:

- The PSU must be single fault tolerant, approved to EN60950-1 and must be connected to a supply incorporating a protective earth conductor. Earthing provisions and residual fault protection for the complete machine are the responsibility of the OEM or installer.
- The system must be PAT tested before the equipment is powered.
- All signal cables **MUST** be screened and all cable screens should be connected electrically to the cable connector's metal shells.
- It is recommended that screens for motor cables should be connected to the shell on the UCC T3 end and connected to the motor housing at the CMM end.
- Signal cables such as tacho and scale cables should be connected to the UCC T3 and have a cable shield that runs to the machine but is left unconnected at the machine end.
- Motor screens should be connected to both the UCC T3 and the motor housing.
- Please refer to appropriate product installation guides when other Renishaw components (PH10, PI 200 etc) are integrated into the system.
- All cables that are used to connect the UCC T3 to the CMM (that are not data cables) must have a minimum cross section of 0.3 mm² (as specified in EN 60204-1 para.12.6). UCC T3 has a maximum voltage of 80 Vdc and peak current is 10 A. The actual peak current will be dependent on the size of the motor fitted and how hard it needs to be driven, so cable sizes need to be calculated by the system installer.
- All cable connectors should be secured to the UCC T3 by the connector jack screws.

The power input to the UCC T3 controller is via a 3W3 connector; refer to the '[Connectors and signals](#)' section for more information.

UCC T3 power requirements

The UCC T3 controller requires 30 W of power to support the controller functions integrated into the unit; this must be factored into the power supply used.

UCC T3 installation guide

www.renishaw.com

UCC T3 controller troubleshooting

Fatal faults

The UCC T3 controller monitors a number of machine input / output signals and internal operational functions. If any of these reach a defined level where the system believes it is dangerous to operate, a fatal fault will be applied.

When a fatal fault is detected it is not possible to engage the servo system. There may be other faults that prevent the CMM from engaging. Not all are reported.

Reported fatal fault	Possible cause
Emergency stop	<ul style="list-style-type: none"> • Emergency stop system activated • Internal failure of servo power amplifier
Air pressure	<ul style="list-style-type: none"> • Air pressure low
Crash	<ul style="list-style-type: none"> • Crash switch activated
Scale failure	<ul style="list-style-type: none"> • Scale readhead failed • Scale "mis-count" • Scale not connected
Overspeed	<ul style="list-style-type: none"> • The position demand has exceeded an internal defined limit • Failure of a tacho feedback • Incorrect scale resolution

Over-temperature shutdown

The UCC T3 unit is designed for continuous power of up to 800 W. The unit will allow a supply current consumption of up to 12 A, which at 80 V is 960 W for a short period of time (1 second).

If this is sustained for a prolonged period, or the unit is not used in an adequate environment such as poor ventilation or high ambient temperature, the unit will disengage the motors to protect itself. An over-temperature warning will be reported.

UCC T3 installation guide

www.renishaw.com

Installation of the UCC T3

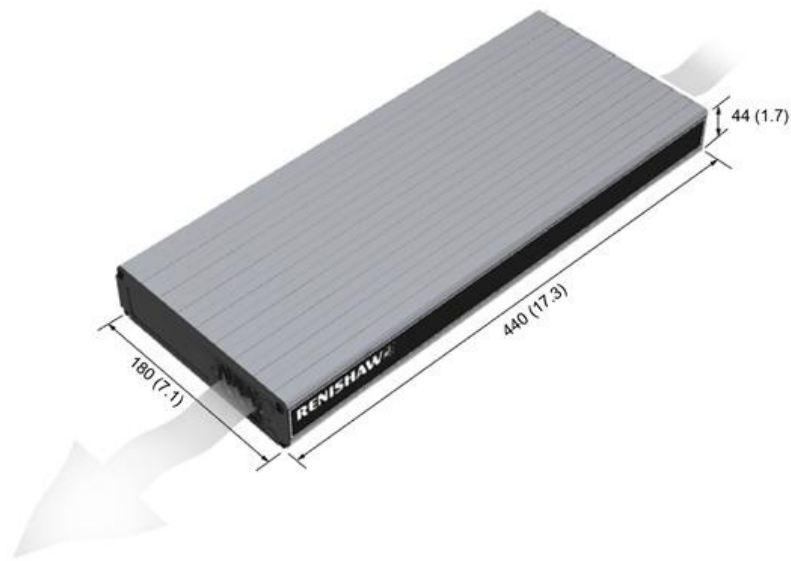

Mounting the UCC T3

The UCC T3 unit draws air from the right hand side when viewed from the front and expels air out of the left hand side. A minimum clearance gap of 10 mm is necessary between the sides of the unit and any potential obstruction. The dimensions shown on the above drawing are in mm (in).

Fitting mounting brackets for 19 inch rack mounting (optional)

Mounting kit (A-5518-0005)

i NOTE: The screws supplied with this kit are M5 × 6 mm countersink type.



UCC T3 installation guide

www.renishaw.com

System interconnections

The UCC T3 provides a simpler means of interconnecting many of the sub-systems (e.g. a probe head) in a measuring system.

TP2 / TP20 / TP6 - two-wire touch-trigger probe system for UCC T3 with manual probe head

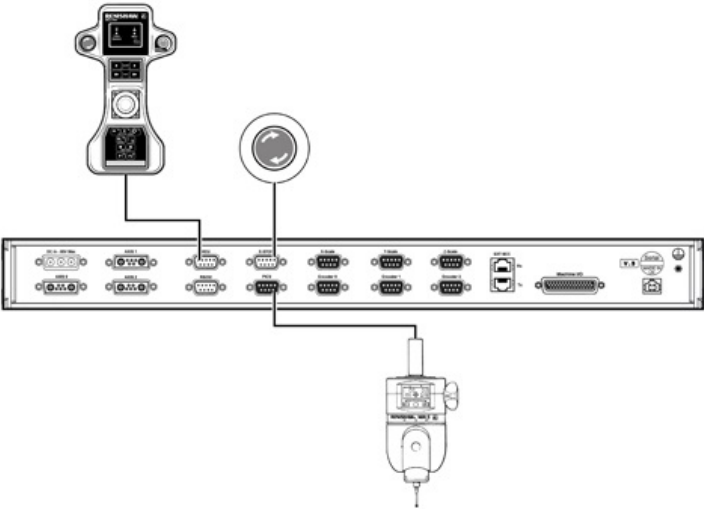

TP200 touch-trigger probe system for UCC T3

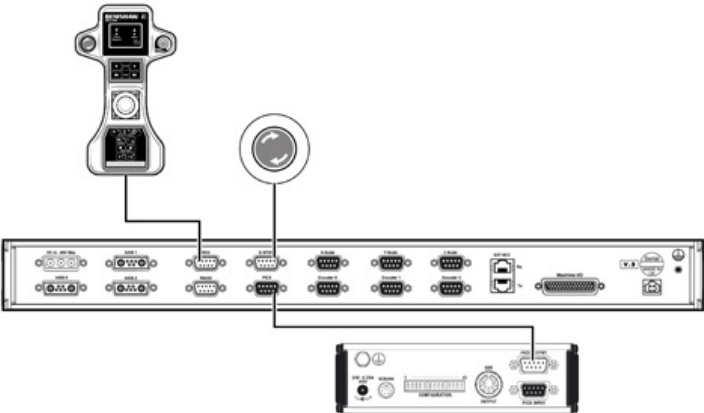

UCC T3 installation guide

www.renishaw.com

PH10 probe head and two-wire touch-trigger probe system for UCC T3

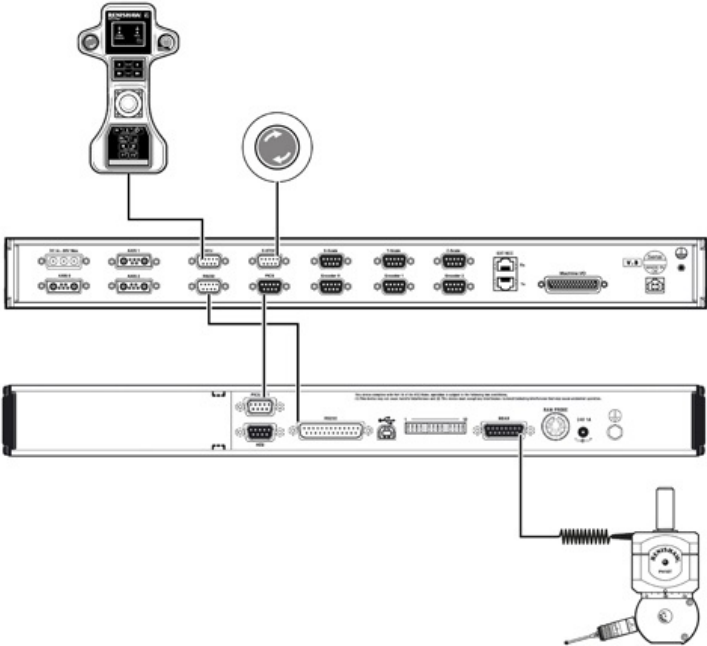

PH10 probe head and TP200 touch-trigger probe system for UCC T3

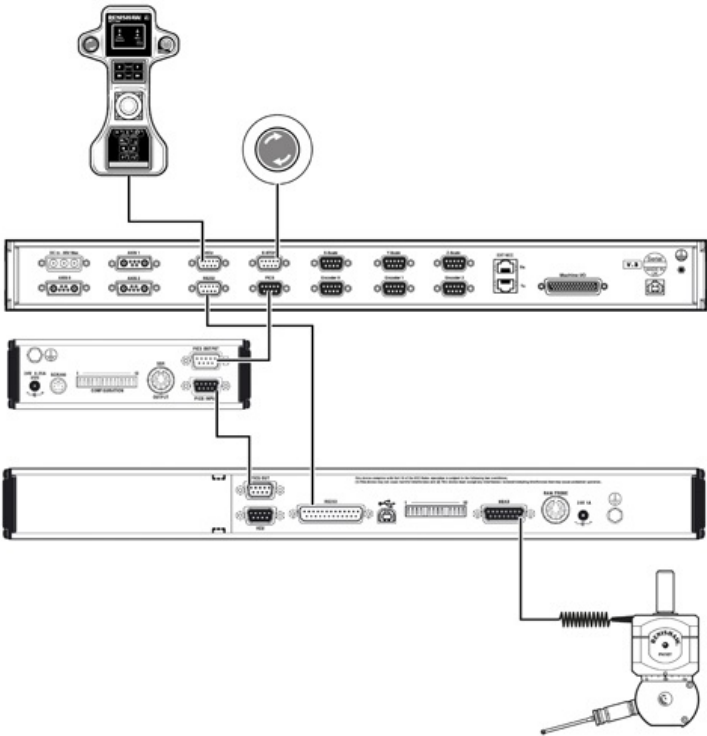

UCC T3 installation guide

www.renishaw.com

UCC T3 visual diagnostics

A visual indication of the system status is provided by four LEDs on the front panel, providing assistance in diagnosing and rectifying system faults.

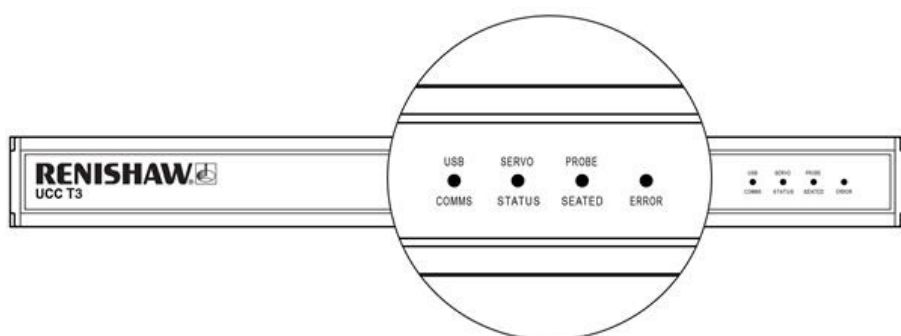

LED status key	Description
	LED on (green / amber / red)
	LED flashing off / on
	LED flashing red / green
	LED off
X	Any condition



USB comms	Servo status	Probe seated	Error	Description
				No power to UCC T3
X		X		Download successful, amps not engaged E-STOP released, amps not engaged
X		X		Download failed, power cycle required
X		X		E-STOP active
X		X		Axes engaged
X		X		Dynamic braking
X	X			Scale error

UCC T3 installation guide

www.renishaw.com



UCC T3 start-up process

When powered on, a self-test and initialisation is performed.

USB comms	Servo status	Probe seated	Error	Description
○	○	○	○	No power to UCC T3
○		○	●	Power applied to UCC T3
○	●	○		Waiting for download

If any of the tests fail, the failure mode is indicated on the status LEDs after about 15 seconds. When power cycling, a minimum of 10 seconds is recommended between power removal and reconnection.

After the UCC T3 has completed its self-test, the system is ready for the software to be downloaded. The sequence of the status LEDs is shown below.

USB comms active	Servo status	Probe seated	Error	Description
○	●	○		Waiting for download
	●	○		Downloading, USB data being passed
X	●	X	○	Download successful

UCC T3 installation guide

www.renishaw.com

Connecting the UCC T3 to the host PC

USB connection

Renishaw's UCCsuite software includes all the necessary drivers and utilities to permit the system to be commissioned and operate under the I++ DME interface protocol. The UCC T3 communicates to the host PC using a USB1.1 communication link. This limits the maximum USB cable distance between the units to 5 m.

Software installation

The UCC T3 controller is supported on UCCsuite version 4.4.5 software or later.

- The UCCsuite software is automatically installed when the application is run
- The software can be obtained online at www.renishaw.com/cmmsupport or from your local Renishaw supplier
- Follow the prompts to install the UCCsuite software by clicking on the "Next" or "Yes" buttons as appropriate
- When the "Installation successfully completed" screen appears, you are ready to connect your UCC T3

Earth bonding scheme to achieve an adequate level of protective earthing and RF immunity

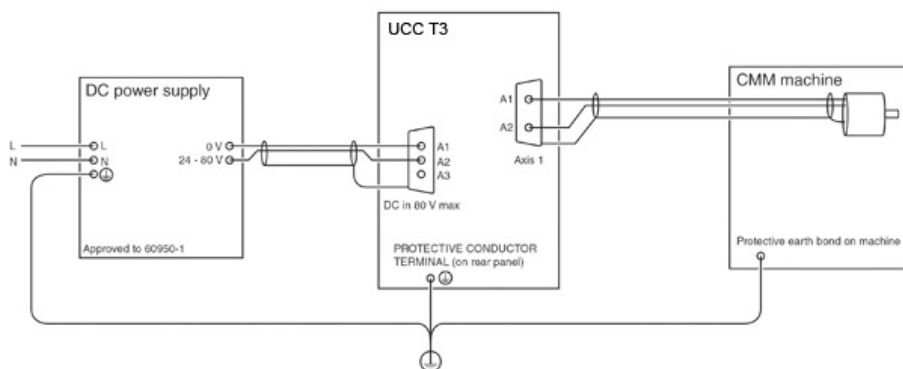

UCC T3 installation guide

www.renishaw.com

Connectors and signals for the UCC T3 controller

Rear panel

The connectors on the rear panel of the UCC T3 controller enclosure are shown below:

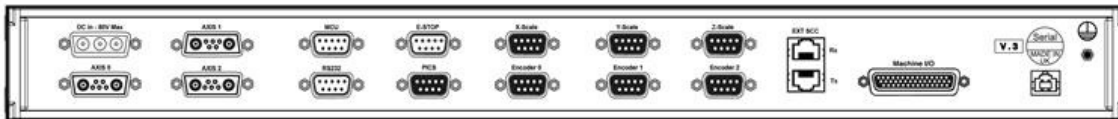

DC power in

3W3 socket. The UCC T3 controller is powered from an external DC power source through this connector, which can be purchased in a connector kit from Renishaw.

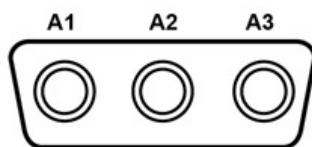

Pin	Function
A1	0 V
A2	24 V to 80 V
A3	0 V

DC power specification

- Voltage 24 V to 80 V
- Current input to 10 A

The UCC T3 controller requires 30 W of power to support the controller functions integrated into the unit. This must be factored into the power supply used.

CAUTION: For ambient temperatures between 40 °C and 50 °C, the maximum input power should be 400 W.

CAUTION: UCC T3 is not recommended for use in ambient temperatures above 50 °C.

UCC T3 installation guide

www.renishaw.com

Regenerating loads

The UCC T3 controller can be attached to motors that cause a regeneration of voltage during the deceleration stage of machine motion. The system integrator must ensure that the power supply used in the installation will permit any regenerative voltage to be accepted without failure.



NOTE: If the power supply is not able to withstand this regenerative voltage from the motors, then a suitable diode must be wired in series with the positive supply to isolate this event.

UCC T3 installation guide

www.renishaw.com

"Axis0, Axis1 and Axis2" motor drive connectors

Each motor connection is a 7W2 connector for connection of a CMM motor to the UCC T3 , as shown below:

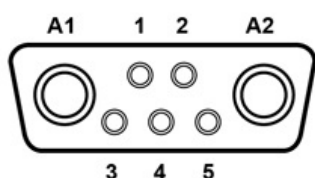

Connector pin	Function
A1	Positive motor connection (default)
A2	Negative motor connection (default)
1	Positive tacho input (default)
2	Negative tacho input (default)
3	Ground reference
4	Negative tacho input (linked to pin 2)
5	Ground reference
Shell	Screen

The table shows the **default** polarity configurations for all pins.



NOTE: The motor and tacho polarities on the UCC T3 controller are software-configured during the installation process. The maximum tacho voltage is 100 V. If one terminal of the tacho is grounded, the maximum voltage is reduced to 18 V. It is recommended that a differential tacho is used.



CAUTION: The UCC T3 motor connections must be blanked off if not being used to prevent accidental contact which could result in an electric shock.

UCC T3 installation guide

www.renishaw.com

MCU connector

Supports the Renishaw MCULite-2, MCU5 and MCU W joysticks.

UCC T3 installation guide

www.renishaw.com

Machine I/O

The 44-way (high density) socket provides connection for the CMM I/O.

The table below details the I/O pinout:

UCC T3 installation guide

www.renishaw.com

Pin no.	Function	Description
1	+24 Vdc	Supply provided for use on CMM switched
2	Air	Output to control an air solenoid
3	X brake	Output to control the X brake
4	Y brake	Output to control the Y brake
5	Z brake	Output to control the Z brake
6	Output 0	General purpose output signal
7 to 12	Reserved	
13	Input 0	General purpose input signal
14	Input 1	General purpose input signal
15 to 19		
20	De-clutch	CMM de-clutch signal
21	Reserved	
22	Low air	Low air pressure switch input
23	Crash	Crash detector switch input
24	Reserved	
25	X axis outer limit	CMM X axis limit switch input
26	- X axis outer limit	CMM X axis limit switch input
27	Y axis outer limit	CMM Y axis limit switch input
28	-Y axis outer limit	CMM Y axis limit switch input
29	Z axis outer limit	CMM Z axis limit switch input
30	-Z axis outer limit	CMM Z axis limit switch input
31	X axis inner limit	CMM X axis limit switch input
32	-X axis inner limit	CMM X axis limit switch input
33	Y axis inner limit	CMM Y axis limit switch input
34	-Y axis inner limit	CMM Y axis limit switch input
35	Z axis inner limit	CMM Z axis limit switch input
36	-Z axis inner limit	CMM Z axis limit switch input
37	24 V return (0 V)	Common reference line for input and output signals
38 to 43	Reserved	
44	24 V return (0V)	Common reference line for input and output signals
Shell	Screen	

UCC T3 installation guide

www.renishaw.com

+24 Vdc

+24 Vdc limited to 1 A.

Air

Pin 2 will be set low (to energise the air solenoid) on boot-up and subsequently, provided there is no air failure. They will be set high on this transistor output signal active low controlled by the “engage command”.

Brakes

During the commissioning process it is possible to invert the output from the brake connections from an active low signal to an active high.

General-purpose output

This is an open collector pulled down to the 0 V (24 V return) line via an NPN transistor when activated. It is suitable for driving devices in the range 5 V to 24 V with a maximum output current of 200 mA. If the output is not required, then it should be left open circuit. The output is protected for excess voltage and over-current within the controller.

Switched inputs

Two uncommitted inputs are provided. Each input is activated by being pulled down to the 0 V (24 V return line). The inputs are not opto-isolated and are pulled up to 24 V via a 10 kohm resistor. These inputs can accept signal levels in the range of +5 V to +48 V, and need to be pulled below 1 V to signify a change in state.

De-clutch

This input on pin 20 should normally be pulled down to the 24 V return line, to signal to the controller that the CMM's drives are mechanically connected to the moving elements of the machine, i.e. in their normal condition. The input should be open circuit, or held high, when a CMM has been temporarily 'de-clutched' from its drive motors to allow manual positioning. The servo system will not drive the motors in this condition and will resume control at the machine's position when the signal again goes low.

Low air pressure

The low air pressure signal should be connected to a suitable air pressure switch. This input is monitored by the controller and when activated will remove power from the motors by causing a system fatal fault. During the commissioning process it is possible to invert this signal from an active low signal to an active high. If this capability is not required for integration to the system, then it should be connected to the 0 V (24 V return line).

Crash

The crash signal is used to inform the UCC T3 of a collision of the mechanical structure of the machine. Typically this is a sensor that is fitted to the end of the CMM quill and if activated will remove power from the motors by causing a system fatal fault.

During the commissioning process it is possible to invert this signal from an active low signal to an active high. If this capability is not required for integration to the system, then it should be connected to the 0 V (24 V return line).

UCC T3 installation guide

www.renishaw.com

Limit switches

The UCC T3 controller supports both inner and outer limit switches for all directions of machine axes. During the commissioning process it is possible to invert this signal from an active low signal to an active high. If this capability is not required for integration to the system, then it should be connected to the 0 V (24 V return line).

Inner limit switches

If an inner limit is activated, the UCC T3 system will perform a maximum movement deceleration in all axes to a stop and then perform a controlled axis back-off in the opposite direction as if a trigger event occurred.

Outer limit switches

If an outer limit is activated the UCC T3 system will immediately disengage all servo power to the machine drives. Recovery of this error is only possible by removing the outer limit switch activation, i.e. by moving the machine off the switch.

0 V (24 V return)

This is the 0 V reference for all the I / O signals.

UCC T3 installation guide

www.renishaw.com

E-STOP

The E-STOP connector is provided to allow connection of an external EMERGENCY STOP switch into the UCC T3 system. The machine manufacturer or product installer must perform a risk assessment to determine the requirements for emergency stopping and emergency switching off. The UCC T3 emergency stop safety system is designed to achieve category 2 or category B implementation as selected by the installer's risk assessment (refer to BS EN ISO13849-1:2008 para. 5.2.2).

The connection on the UCC T3 is a 9WD plug connector with the following connections:

Pin number	Function	Pin number	Function
1	E-STOP A (+24 V)	6	E-STOP A (+24 V)
2	Not connected	7	E-STOP B2
3	0 V	8	Not connected
4	E-STOP B1	9	RESET
5	Not connected		

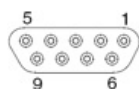

E-STOP connector - view on face of socket (rear of plug)

E-STOP electrical characteristics

Any emergency stop components fitted to this connector must have the following electrical characteristics:

Emergency stop system voltage: 24 V

Emergency stop system current: 1 A

All connections to this connector should be fitted by a competent technician or engineer and all wires should be sleeved. Any emergency stop devices added to the E-STOP chain should meet the requirements of IEC 60947-5-1 (Low-voltage switchgear and control gear – Part 5-1: Control circuit devices and switching elements – Electromechanical control circuit devices) or UL1054 (Standard for special-use switches).



NOTE: If there are no additional emergency stop devices to be added to the system, connect pin 1 to pin 4, and pin 6 to pin 7 to permit the UCC T3 emergency stop switch to function.



NOTE: If the RESET signal is not used, connect pin 6 (E-STOP A) to pin 9 (RESET).

If indicated by the user's risk assessment, a 'manual reset' button (refer to BS EN ISO13849-1:2008 para. 5.2.2.) should be included in the emergency stop system. A reset switch is required when there is limited visibility of the danger zone from the control position. The reset switch must be positioned outside the danger zone and in a safe position from which it may be determined that no person is within the danger zone before resetting the safety system.

UCC T3 installation guide

www.renishaw.com

i **NOTE:** Periodically cycle E-STOP buttons, reset push buttons and check for correct position.

--	--

The E-STOP buttons should be cycled regularly by operators to ensure correct operation, the frequency of testing having been determined by user risk assessment.

If the reset push button has been fitted, it should be tested regularly by operators to ensure correct operation, the frequency of testing having been determined by user risk assessment.

! **CAUTION:** It is strongly recommended that the CMM manufacturer or retrofitter includes a periodic test of the emergency stop and, if fitted, the associated reset switch, in their maintenance instructions.

E-STOP with reset implementation

There are five methods of implementing the E-STOP circuit.

Single pole E-STOP E-STOP button with reset:

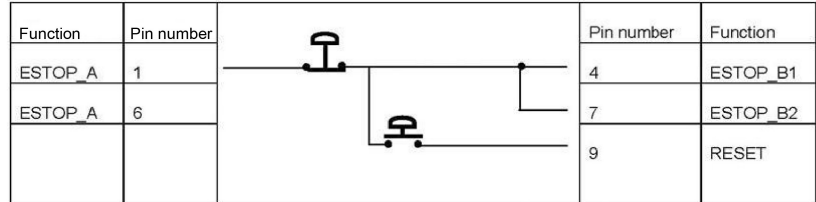

Dual pole E-STOP button with reset:

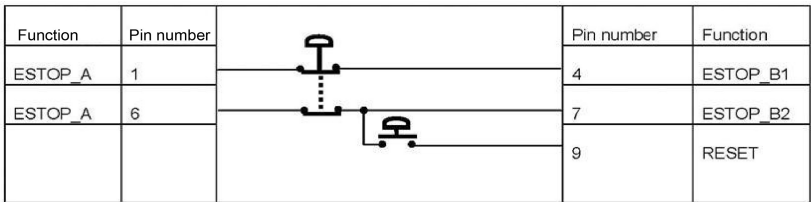

E-STOP without reset implementation

Single pole E-STOP button without reset:

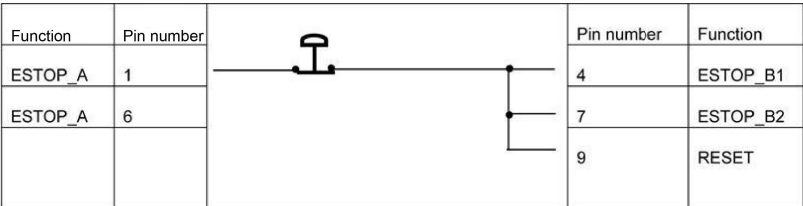

Dual pole E-STOP button without reset:

UCC T3 installation guide

www.renishaw.com

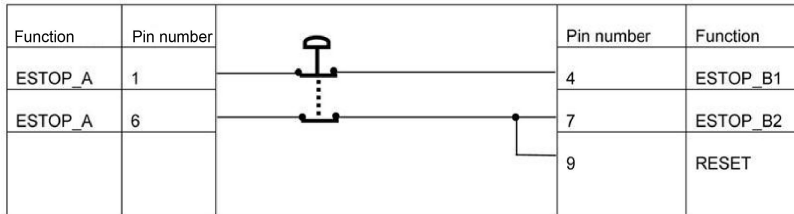

Bypass plug

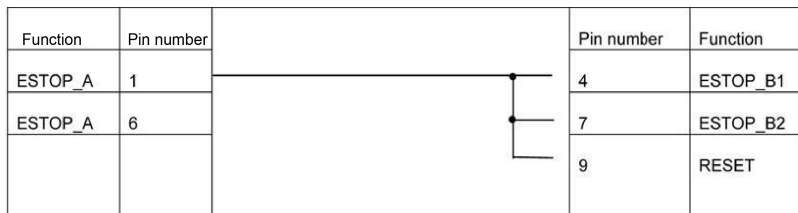

E-STOP safety test

The E-STOP buttons should be regularly inspected to ensure that they are in good working order and easily accessible. It should also be tested as follows:

1. Ensure that the probe head is free to move in all six directions, using the MCU joystick.
2. Hit the emergency stop button. For some systems, the button must then be unlocked by twisting it, as indicated by the arrows on the button.
3. Ensure that the probe head cannot be moved, using the MCU joystick.
4. Re-engage the servos using the button on the MCU and check that the probe head can now move again.

UCC T3 installation guide

www.renishaw.com

Serial comms: RS232

This connector is for use with a Renishaw motorised head controller (PHC10-3 PLUS). Further details can be found in the Renishaw PHC10-3 PLUS installation guide H-1000-0077.

Pin number	Function	Pin number	Function
1	Not connected	6	Not connected
2	Rx	7	RTS
3	Tx	8	CTS
4	DTR (high)	9	Not connected
5	0 V GND	Shell	Screen

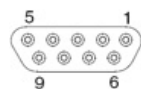

Serial comms - view on face of socket (rear of plug)

Communication settings

This port is configured for the following communication settings:

Baud rate	9600
Data	7 bits
Parity	Even
Stop	1 bit

Connection to a PHC10-3

To connect a PHC10-3 to the controller, the following settings are needed:

PHC10-3 dip switches:

1	2	3	4	5	6	7	8	9	10	11	12	13
U	D	U	D	D	D	D	D	U	D	U	U	U

U = up

D = down

The cable connection for a PHC10-3 to a UCC T3 is as detailed below or can be purchased from Renishaw, part number A-5567-1622.

UCC T3 installation guide

www.renishaw.com

PHC10-3 25-way D connector	Signal	UCC T3 9-way D connector
Pin 2	Tx →	Pin 2
Pin 3	Tx ←	Pin 3
Pin 4	RTS → CTS	Pin 8
Pin 5	CTS ← RTS	Pin 7
Pin 7	Ground	Pin 5

UCC T3 installation guide

www.renishaw.com

PICS connector

The PICS connector can either be:

- Connected directly to the probe – in this configuration the UCC T3 will operate as the probe interface.
- Connected to a probe interface (PI 200-3) - in this configuration the UCC T3 will accept the trigger signals from the unit.

The connector is a 9-pin D socket, pinout as follows:

Pin number	Function	Pin number	Function
1	PICS STOP	6	Reserved
2	PICS probe power off (PPOFF)	7	PICS probe damping (PDAMP)
3	0 V	8	PICS LED off (LEDOFF)
4	PICS LED anode	9	Probe common
5	Probe signal	Shell	Screen

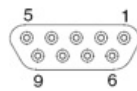

PICS connector - view of face of socket (rear of plug)

UCC T3 installation guide

www.renishaw.com

Scale inputs

Provides RS422 compatible scale inputs for each of the machine axes through the 15 W HDD connectors.

NOTE: If the machine scale is of a different format (e.g. analogue, single-ended), then this will require an external adaptor.

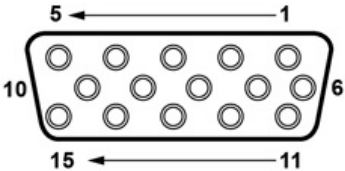

Pin number	Function	Pin number	Function
1	External N/C	9	
2	0 V supply	10	+ Error / limit switch Q
3	- Error	11	Limit switch P
4	- Reference mark	12	+ Reference mark
5	- B signal	13	+ B signal
6	- A signal	14	+ A signal
7	+ 5.25 V supply	15	Inner screen
8	Reserved	Shell	

Scale supply voltage is 5.25 V at 350 mA from each readhead connector. Scale quadrature signals with ideal waveforms and phase displacement with an edge rate of up to 40 MHz.

Scale input signals to be to EIA specification RS-422:

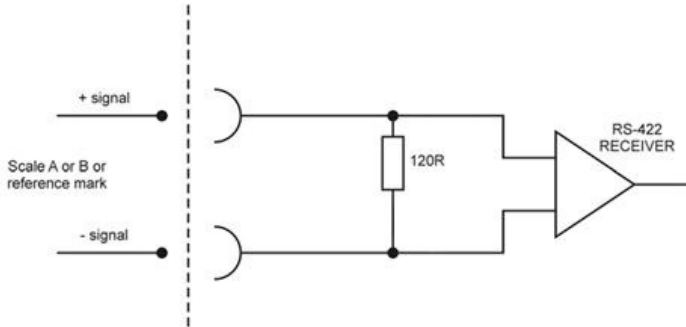

UCC T3 input circuits for CMM readhead - scale and reference mark inputs

UCC T3 installation guide

www.renishaw.com

UCC T3 error interface circuit

Supports the error signal as integrated to the Renishaw range of RGH24 readheads. If the error signal is not integrated into the connected readhead, then it is necessary to configure the connection as indicated below.

- -error (pin 3) link to 5.25 V (pin 7)

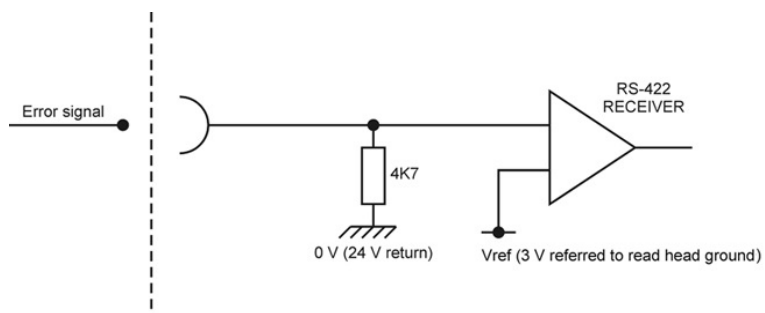

UCC T3 installation guide

www.renishaw.com

Limit switch interface circuit

Scale based limit switch error signals are as integrated to the Renishaw range of RGH24 readheads.

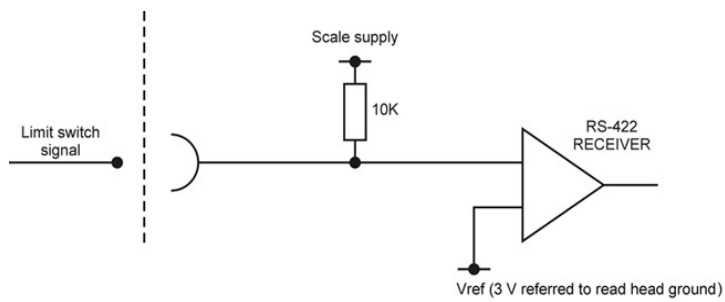

UCC T3 installation guide

www.renishaw.com

Encoder

Encoder based feedback for motor speed sensing via high density 15-way 'D' sockets which are designed to accept RS422 compliant signals.

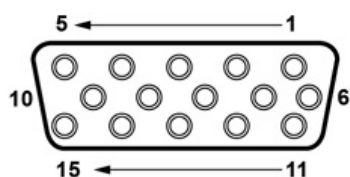

Pin number	Function	Pin number	Function
1	Not connected	9	0 V supply
2	0 V supply	10	Not connected
3	Not connected	11	Not connected
4	Not connected	12	Not connected
5	- B signal	13	+ B signal
6	- A signal	14	+ A signal
7	+ 5V supply	15	0 V supply
8	+ 5V supply	Shell	Screen

Supply 5.25 V at 350 mA from each encoder connector.

UCC T3 installation guide

www.renishaw.com

EXT SSC

No connection required.

UCC T3 installation guide

www.renishaw.com

Maintenance

Filter replacement

The UCC T3 controller has a positive air flow within its enclosure for cooling purposes; this system has a replaceable filter to protect it from the ingress of dust. The machine operator should check the condition of this filter on a regular basis. It is recommended that this filter is removed and checked then replaced as necessary during the machine installer or retrofitter's regular maintenance routine.

Exchanging / removing the air filter

The following procedure is recommended when exchanging / removing the air filter:

1. Remove power from the controller.
2. Remove the 19 inch rack mounting brackets (if fitted) by removing the two fixing screws.
3. Individually pull the heads of both the filter-retaining clips away from the unit about 5 mm for them to disengage. This should permit the external filter cover to be pulled away.
4. Remove the filter material from the filter recess.
5. Replace the filter, reversing the steps given above (the part number of the replacement filter is A-5518-0011).

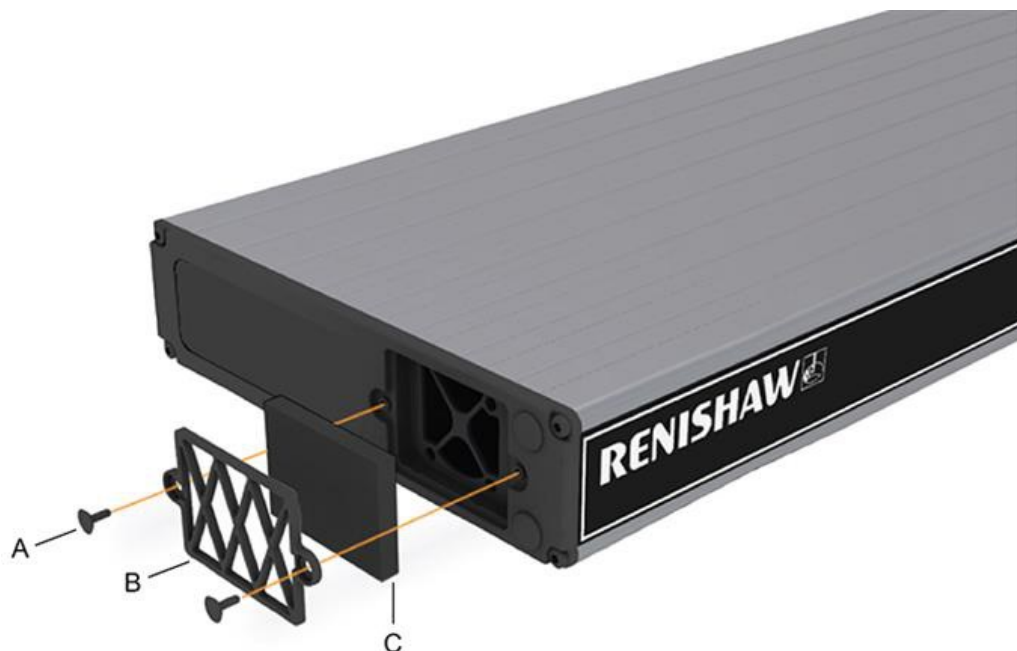

UCC T3 installation guide

www.renishaw.com

Renishaw address

Renishaw plc
New Mills
Wotton-under-Edge
Gloucestershire
GL12 8JR
United Kingdom
+44 1453 524524

UCC T3 installation guide

www.renishaw.com

Appendix 1 - International safety statements

BG: Препоръки за безопасност за контролера UCC T3

Условия на околната среда

Използване на закрито	IP30* (BS EN60529:1992)
Височина	до 2 000 м
Работна температура	От +5 °C до +50 °C
Температура за съхранение	От -25 °C до +70 °C
Относителна влажност	80% максимум (без кондензация) при температури до +31 °C Линейно намаление до 50% при +40 °C
Преходни напрежения	Installation category II
Степен на замърсяване	2



ЗАБЕЛЕЖКА: Може да се наложи да се сложи UCC T3 в подходящ електрически изолиран корпус съобразно условията на околната среда на инсталацията за получаване на по-висок клас на защита IP.



ЗАБЕЛЕЖКА: За околни температури под 40 градуса по Целзий, максималната входна мощност за UCC T3 е 800 Вт. При температури между 40 °C и 50 °C максималната мощност е 400 Вт.



ПРЕДУПРЕЖДЕНИЕ: UCC T3 не се препоръчва за употреба при температури над 50 °C.



ПРЕДУПРЕЖДЕНИЕ: Осигуряването на условия за заземяване на комплектната машина е отговорност на производителя на оригиналното оборудване или монтажника.



ПРЕДУПРЕЖДЕНИЕ: Изолация: UCC T3 се изолира от постояннотокотово захранване чрез откачване на съединителя на захранването. Ако се изискват допълнително средство за изолиране, то трябва да бъде посочено и монтирано от производителя на машината или монтажника на изделието. Изолаторът трябва да е разположен с лесен достъп до него от оператора на КИМ и да отговаря на IEC61010 и всяка приложима нормативна уредба за опроводяване в страната на монтажа.



ПРЕДУПРЕЖДЕНИЕ: Захранващото устройство трябва да бъде толерантно към единични грешки, одобрено по EN60950-1 и трябва да бъде свързано със захранване, включващо защитен заземителен проводник. Осигуряването на условия за заземяване и защита от остатъчни грешки на комплектната машина е отговорност на производителя на оригиналното оборудване или монтажника.

UCC T3 installation guide

www.renishaw.com

Безопасност на машината



ПРЕДУПРЕЖДЕНИЕ: Изключването или изолирането на UCC T3 HE може да предотврати неочаквано движение машина. На потребителя се препоръчва да изолира устройството от електрозахранването, сгъстен въздух или други източници на енергия в съответствие с инструкциите на производителя на машината, преди да влезе в опасната зона, или да извършва някакви дейности по поддръжка.

Ако оборудването се използва по начин, който не е указан от производителя, осигуряваната от оборудването защита може да се влоши.

Предпазната система за аварийно спиране, която е вградена в контролера UCC T3, има за цел да постигне категория 2 по стандарт BS EN ISO13849-1:2008, като това може да бъде конфигуриран хардуер за получаване на категория В. Оценката на риска от страна на монтажника на инсталацията е трябвало да определи коя категория е необходима.

UCC T3 трябва да бъде въведен в експлоатация само чрез софтуера на Renishaw, като неизпълнението на това изискване може да доведе до неочаквано движение на машината.

CS: Bezpečnostní doporučení pro řídicí systém UCC T3

Podmínky prostředí

Pro vnitřní použití	IP30* (BS EN60529:1992)
Nadmořská výška	až 2 000 m
Rozsah pracovních teplot	+5 °C až +50 °C
Rozsah skladovacích teplot	-25 °C až +70 °C
Relativní vlhkost	Maximálně 80% (nekondenzující) pro teploty do +31 °C Lineární pokles na 50% při +40 °C
Přechodná napětí	Installation category II
Stupeň znečištění	2



POZNÁMKA: Může být zapotřebí umístit systém UCC T3 do vhodného elektrického krytu podle podmínek prostředí instalace, abyste docílili vyšší třídy krytí IP.



POZNÁMKA: Při teplotách okolí pod 40 °C je maximální příkon systému UCC T3 800 W. Při teplotách mezi 40 °C a 50 °C je maximální příkon 400 W.



UPOZORNĚNÍ: Nedoporučuje se používat systém UCC T3 při teplotách okolí nad 50 °C.



UPOZORNĚNÍ: Za zajištění uzemnění celého stroje odpovídá výrobce OEM nebo ten, kdo ho instaluje.

UCC T3 installation guide

www.renishaw.com



UPOZORNĚNÍ: Odpojení: Systém UCC T3 se odpojuje od napájení stejnosměrným proudem odpojením napájecího konektoru. Je-li zapotřebí další prostředek pro odpojení, musí být specifikován a instalován výrobcem stroje nebo tím, kdo produkt instaluje. Odpojovací prvek musí být umístěn ve snadném dosahu obsluhy souřadnicového měřicího stroje a splňovat normu IEC61010 a všechny příslušné státní předpisy pro zapojení platné v zemi instalace.



UPOZORNĚNÍ: Napájecí zdroj musí být odolný vůči jednoduchým poruchám, schválený podle normy EN60950-1 a musí být připojený k napájení vybavenému ochranným zemnicím vodičem. Za zajištění uzemnění a ochranu před zbytkovou chybou pro celý stroj odpovídá výrobce OEM nebo ten, kdo ho instaluje.

Bezpečnost stroje



UPOZORNĚNÍ: Vypnutí nebo odpojení systému UCC T3 NEMUSÍ zabránit nečekanému pohybu stroje. Uživatelé se doporučuje odpojit stroj od elektrického napájení, přívodu stlačeného vzduchu nebo jiných zdrojů energie v souladu s pokyny výrobce stroje dříve, než vstoupí do nebezpečného prostoru nebo bude provádět jakékoliv činnosti údržby.

Pokud je zařízení používáno způsobem, který není specifikován výrobcem, může dojít ke snížení ochrany poskytované zařízením.

Bezpečnostní systém pro nouzové zastavení zabudovaný do řídicího systému UCC T3 je navržen pro dosažení kategorie 2 podle normy BS EN ISO13849-1:2008, konfigurací hardwaru lze dosáhnout kategorie B. Vyhodnocení rizik provedené při instalaci tím, kdo systém instaluje, musí tedy určit, která kategorie je zapotřebí.

Systém UCC T3 musí být uveden do provozu pouze pomocí softwaru společnosti Renishaw, nedodržení této podmínky může způsobit nečekaný pohyb stroje.

DA: Sikkerhedsanbefalinger for UCC T3-styring

Miljømæssige forhold

Indendørs brug	IP30* (BS EN60529:1992)
Højde	op til 2000 m
Driftstemperatur	+5 °C til +50 °C
Opbevaringstemperatur	-25 °C til +70 °C
Relativ fugtighed	80% maksimum (ikke-kondenserende) for temperaturer op til +31 °C Lineær reduktion til 50% ved +40 °C
Transiente spændinger	Installation category II
Forureningsgrad	2



BEMÆRK: Det kan være nødvendigt at anbringe UCC T3 i en egnet elektrisk indkapsling i overensstemmelse med de miljømæssige forhold ved installationen for at opnå en højere IP-værdi.

UCC T3 installation guide

www.renishaw.com



BEMÆRK: For omgivelsestemperaturer under 40 °C er den maksimale indgangseffekt for UCC T3 800 W. For temperaturer mellem 40 °C og 50 °C er den maksimale effekt 400 W.



ADVARSEL: UCC T3 anbefales ikke til brug ved omgivelsestemperaturer over 50 °C.



ADVARSEL: Ansvaret for bestemmelserne om jordforbindelse for hele maskinen ligger hos OEM eller installatør.



ADVARSEL: Isolation: UCC T3 isoleres fra DC-strømforsyningen ved frakobling af strømstikket. Hvis der kræves yderligere måder at afbryde strømforsyningen på, skal de være specificeret og monteret af maskinproducenten eller installatøren af produktet. Afbryderen skal være placeret, så CMM-operatøren nemt kan nå den, og den skal overholde IEC61010 og eventuelle andre relevante nationale regulativer for ledningsføring i det land, hvor installationen foretages.



ADVARSEL: Strømforsyningen (PSU) skal være fejltolerant overfor enkelt-fejl, godkendt af EN60950-1 og tilsluttet til en strømforsyning med en beskyttende jordforbindelse. Ansvaret for bestemmelserne om jordforbindelse og fejlstrømsbeskyttelse for hele maskinen ligger hos OEM eller installatør.

Maskinsikkerhed



ADVARSEL: Slukning eller isolation af UCC T3 forhindrer muligvis IKKE uventet bevægelse af maskinen. Det anbefales at brugeren isolerer maskinen fra el-forsyning, trykluft eller andre energikilder i overensstemmelse med maskinproducentens vejledning, før vedkommende går ind i en farezone eller foretager nogen form for vedligeholdelse.

Hvis udstyret anvendes på en måde, som ikke er specificeret af producenten, kan udstyrets beskyttelse blive påvirket.

Nødstopssystemet, der er blevet integreret i UCC T3-styringen, er designet til at opnå kategori 2 i standard BS EN ISO13849-1:2008. Dette kan være hardwarekonfigureret for at opnå kategori B. Den risikovurdering, der er foretaget af systeminstallatøren, har derfor fastlagt, hvilken kategori der er nødvendig.

UCC T3 må kun idriftsættes via Renishaw software – i modsat fald kan der ske uventet bevægelse af maskinen.

DE: Sicherheitsempfehlungen für die UCC T3-Steuerung

Umgebungsbedingungen

UCC T3 installation guide

www.renishaw.com

Einsatz im Haus/Messraum	IP30* (BS EN60529:1992)
Höhe ü.NN	bis 2.000 m
Zulässiger Temperaturbereich im Betrieb	+5 °C bis +50 °C
Zulässiger Temperaturbereich für die Lagerung	-25 °C bis +70 °C
Relative Luftfeuchtigkeit	Max. 80% (nicht kondensierend) für Temperaturen bis zu +31 °C Linearer Abfall auf 50% bei +40 °C
Kurzzeitige Überspannungen	Installation category II
Verschmutzungsgrad	2



HINWEIS: Je nach Umgebungsbedingungen am Aufstellort ist die UCC T3-Steuerung möglicherweise in einem geeigneten Elektrogehäuse unterzubringen, um eine höhere IP-Schutzklasse zu erreichen.



HINWEIS: Bei Umgebungstemperaturen unter 40 °C beträgt die maximale Eingangsleistung für die UCC T3 800 W. Bei Temperaturen zwischen 40 °C und 50 °C beträgt die maximale Spannungsversorgung 400 W.



ACHTUNG: UCC T3 sollte nicht in Umgebungstemperaturen über 50 °C eingesetzt werden.



ACHTUNG: Für die Erdung der kompletten Maschine ist der Maschinenhersteller bzw. Installationstechniker verantwortlich.



ACHTUNG: Isolierung: UCC T3 wird durch Abziehen des Netzgerätesteckers von der Spannungsversorgung getrennt. Wird eine weitere Abschaltmöglichkeit benötigt, ist diese zu spezifizieren und vom Maschinenhersteller oder Installationstechniker für das Produkt einzubauen. Der Trennschalter muss für den CMM-Bediener leicht erreichbar sein und IEC61010-Bestimmungen, wie auch alle anderen gültigen nationalen Verdrahtungsvorschriften im Installationsland erfüllen.



ACHTUNG: Das Stromversorgungsmodul muss das Kriterium der Einzelfehlertoleranz erfüllen, gemäß EN60950-1 zugelassen sein und an eine Spannungsversorgung mit Schutzleiter angeschlossen werden. Für die Erdung und den weiteren Fehlerstromschutz der kompletten Maschine ist der Maschinenhersteller bzw. Installationstechniker verantwortlich.

Maschinensicherheit



ACHTUNG: Das Abschalten der UCC T3 oder Trennen ihrer Spannungsversorgung ist KEIN Schutz vor unerwarteten Maschinenbewegungen. Der Bediener sollte, gemäß der Herstelleranweisung, die Stromversorgung, Druckluft und andere Energiequellen der Maschine trennen, bevor er die Gefahrenzone betritt bzw. Wartungsarbeiten durchführt.

Wird das Gerät für einen nicht vom Hersteller spezifizierten Zweck benutzt, kann dies zu einer Beeinträchtigung des vom Gerät bereitgestellten Schutzes führen.

UCC T3 installation guide

www.renishaw.com

Die in der UCC T3-Steuerung integrierte Notaus-Sicherheitsvorrichtung wurde entwickelt, um Kategorie 2 des Standards BS EN ISO13849-1:2008 zu genügen. Über eine Konfiguration der Hardware kann Kategorie B erzielt werden. Die Risikobeurteilung, die der Installationstechniker bei Einrichtung des Systems vorgenommen hat, sollte daher eine Angabe enthalten, welche Kategorie benötigt wird.

Die UCC T3 darf ausschließlich durch Renishaw Software betrieben werden. Die Nichtbeachtung dieser Vorschrift kann zu unerwarteten Maschinenbewegungen führen.

EL: Συστάσεις ασφαλείας για τον ελεγκτή UCC T3

Περιβαλλοντικές συνθήκες

Χρήση σε εσωτερικό χώρο	IP30* (BS EN60529:1992)
Υψόμετρο	έως 2000 m
Θερμοκρασία λειτουργίας	+5 °C έως +50 °C
Θερμοκρασία αποθήκευσης	-25 °C έως +70 °C
Σχετική υγρασία	μέγιστο 80% (χωρίς συμπύκνωση) για θερμοκρασίες έως +31 °C Γραμμική μείωση σε 50% στους +40 °C
Μεταβατικές τάσεις	Installation category II
Βαθμός μόλυνσης	2

 **ΣΗΜΕΙΩΣΗ:** Ίσως απαιτείται να στεγάσετε τον UCC T3 σε ένα κατάλληλο ηλεκτρικό περίβλημα σύμφωνα με τις περιβαλλοντικές συνθήκες της εγκατάστασης, ώστε να λάβετε μια υψηλότερη κατηγορία IP.

 **ΣΗΜΕΙΩΣΗ:** Για θερμοκρασίες περιβάλλοντος κάτω των 40 βαθμών Κελσίου, η μέγιστη ισχύς εισόδου για τον UCC T3 είναι 800 W. Σε θερμοκρασίες μεταξύ 40 °C και 50 °C, η μέγιστη ισχύς είναι 400 W.

 **ΠΡΟΣΟΧΗ:** Ο UCC T3 δεν προτείνεται για χρήση σε θερμοκρασίες περιβάλλοντος άνω των 50 °C.

 **ΠΡΟΣΟΧΗ:** Η παροχή γείωσης για ολόκληρο το μηχάνημα είναι ευθύνη του Κατασκευαστή αρχικού εξοπλισμού ή του εγκαταστάτη.

 **ΠΡΟΣΟΧΗ:** Θέση εκτός τάσης: Ο UCC T3 απομονώνεται από την παροχή ισχύος συνεχούς ρεύματος (DC) αποσυνδέοντας το βύσμα ισχύος. Εάν απαιτούνται οποιαδήποτε συμπληρωματικά μέσα απομόνωσης, πρέπει αυτά να καθοριστούν και να τοποθετηθούν από τον κατασκευαστή της μηχανής ή από τον εγκαταστάτη του προϊόντος. Ο απομονωτής πρέπει να βρίσκεται σε σημείο εύκολα προσβάσιμο από το χειριστή του CMM και να συμμορφώνεται με το πρότυπο IEC61010 και με οποιουδήποτε εφαρμοζόμενους εθνικούς κανονισμούς καλωδιώσεων για τη χώρα εγκατάστασης.

 **ΠΡΟΣΟΧΗ:** Το PSU πρέπει να έχει ανοχή ενός σφάλματος, έγκριση σύμφωνα με το EN60950-1 και πρέπει να έχει συνδεθεί σε τροφοδοσία, η οποία θα περιλαμβάνει αγωγό προστατευτικής γείωσης. Η παροχή γείωσης και η υπολειπόμενη προστασία

UCC T3 installation guide

www.renishaw.com

 σφάλματος για ολόκληρο το μηχάνημα είναι ευθύνη του Κατασκευαστή αρχικού εξοπλισμού ή του εγκαταστάτη.

Ασφάλεια μηχανήματος



ΠΡΟΣΟΧΗ: Η διακοπή ή απομόνωση του UCC T3 ΔΕΝ μπορεί να εμποδίσει μη αναμενόμενη κίνηση του μηχανήματος. Συνιστάται στο χρήστη να απομονώνει το μηχάνημα από την ηλεκτρική τροφοδοσία, τον συμπιεσμένο αέρα ή άλλες πηγές ενέργειας σύμφωνα με τις οδηγίες του κατασκευαστή μηχανήματος, προτού εισέλθει στην επικίνδυνη ζώνη ή προτού διεξάγει οποιεσδήποτε εργασίες συντήρησης.

Εάν ο εξοπλισμός χρησιμοποιείται με τρόπο μη προδιαγεγραμμένο από τον κατασκευαστή, η παρεχόμενη προστασία του εξοπλισμού πιθανώς να παρεμποδίζεται.

Το σύστημα Σταματήματος Έκτακτης Ανάγκης το οποίο έχει ενσωματωθεί στον ελεγκτή UCC T3 είναι σχεδιασμένο ώστε να επιτυγχάνει την κατηγορία 2 στο πρότυπο BS EN ISO13849-1:2008. Σε αυτό μπορεί να γίνει διαμόρφωση του υλικού ώστε να λαμβάνεται η κατηγορία B. Για το λόγο αυτό με την αξιολόγηση κινδύνου που γίνεται από τον εγκαταστάτη συστήματος κατά την εγκατάσταση πρέπει να καθορίζεται ποια κατηγορία απαιτείται.

Ο UCC T3 πρέπει να τίθεται σε λειτουργία μόνο μέσω του λογισμικού της Renishaw. Σε αντίθετη περίπτωση το αποτέλεσμα μπορεί να είναι μη αναμενόμενη κίνηση του μηχανήματος.

ES: Recomendaciones de seguridad del control UCC T3

Condiciones ambientales

Uso en interiores	IP30* (BS EN60529:1992)
Altitud	hasta 2.000 m
Temperatura de funcionamiento	+5 °C a +50 °C
Temperatura de almacenamiento	-25 °C a +70 °C
Humedad relativa	80% máximo (sin condensación) para temperaturas hasta +31 °C Reducción lineal hasta el 50% a +40 °C
Voltaje de sobretensión	Installation category II
Nivel de contaminación	2



NOTA: Dependiendo de las condiciones ambientales de la instalación, podría ser necesario ubicar el control UCC T3 en un armario eléctrico adecuado para obtener una tasa de IP superior.



NOTA: Para temperaturas ambientales hasta 40 °C, la potencia máxima de entrada del control UCC T3 es de 800 W. Para temperaturas entre 40 °C y 50 °C, la potencia máxima es de 400 W.



ADVERTENCIA: Se recomienda no utilizar el control UCC T3 con una temperatura ambiente superior a 50 °C.

UCC T3 installation guide

www.renishaw.com



ADVERTENCIA: Las conexiones de toma a tierra necesarias para toda la máquina son responsabilidad del fabricante de la máquina o el instalador.



ADVERTENCIA: Aislamiento: El control UCC T3 se aísla de la alimentación de CC desconectando el interruptor de alimentación. Si es necesario algún otro método de aislamiento adicional, debe especificarse e instalarse por el fabricante de la máquina o el instalador del producto. El aislante se colocará en un punto de fácil acceso para el operario de la MMC, y debe cumplir la norma IEC61010 y las regulaciones de cableado correspondientes al país de la instalación.



ADVERTENCIA: La unidad de alimentación o PSU debe ser tolerante a fallos sencillos, según la norma EN60950-1, y debe conectarse a la fuente de alimentación mediante un cable con protección de toma de tierra. Las conexiones de toma a tierra y la protección contra fallos residuales necesarias para toda la máquina son responsabilidad del fabricante o el instalador.

Seguridad de la máquina



ADVERTENCIA: Apagar o aislar el control UCC T3 NO evita necesariamente un movimiento imprevisto de la máquina. Para evitar movimientos imprevistos, el operario deberá desconectar la máquina de la toma eléctrica, el aire comprimido o cualquier otra fuente de energía, según las instrucciones del fabricante, antes de acceder a zonas peligrosas o realizar operaciones de mantenimiento.

Si no se cumplen las indicaciones especificadas por el fabricante para la utilización del equipo, la protección del equipo puede resultar inutilizada.

El sistema de seguridad de parada de emergencia integrado en el control UCC T3 ha sido diseñado para cumplir la categoría 2 del estándar BS EN ISO13849-1:2008, no obstante, el hardware puede configurarse para obtener la categoría B. La categoría necesaria deberá ser determinada por el técnico de sistemas mediante la evaluación de riesgos durante la instalación.

El control UCC T3 debe utilizarse únicamente mediante el software de Renishaw, de lo contrario, pueden producirse movimientos imprevistos de la máquina.

ET: UCC T3 kontrolleri ohutusjuhend

Keskkonnatingimused

UCC T3 installation guide

www.renishaw.com

Kasutamine siseruumides	IP30* (BS EN60529:1992)
Kõrgus	kuni 2000 m
Töötemperatuur	+5 °C kuni +50 °C
Hoidmistemperatuur	-25 °C kuni +70 °C
Suhteline õhuniiskus	Maksimaalselt 80% (mittekondenseeruv) kuni +31 °C temperatuuride puhul Lineaarne vähenemine 50%-ni temperatuuril +40 °C
Siirdepinged	Installation category II
Saasteaste	2



MÄRKUS: Suurema IP-taseme saamiseks võib olla vajalik paigutada UCC T3 paigalduskoha keskkonnatingimustele vastavasse sobivasse elektrilisse ümbrisesse.



MÄRKUS: Madalama kui 40 °C ümbritseva temperatuuri korral on UCC T3 suurim sisendvõimsus 800 W. Temperatuurivahemikus 40 °C kuni 50 °C on suurim võimsus 400 W.



HOIATUS: UCC T3 ei soovitata kasutada kõrgema kui 50 °C ümbritseva temperatuuri juures.



HOIATUS: Maandamisvõimaluste loomine masinale tervikuna on seadmete tootja või paigaldaja kohustus.



HOIATUS: Isolatsioon. UCC T3 on vahelduvvooluvarustusest isoleeritud voolulüliti lahtiühendamise kaudu. Kui esineb vajadus täiendavate isoleerimisviiside järele, tuleb need määratleda ja paigaldada masina tootjal või toote paigaldajal. Isolaator peab asuma koordinaatmootemasina operaatorile kergelt ligipääsetavas kohas ja olema kooskõlas IEC61010 ning teiste juhtmestikke puudutavate kohalduvate riiklike eeskirjadega.



HOIATUS: PSU peab olema ühe rikke kindel, EN60950-1 kohase heakskiiduga ning ta peab olema ühendatud kaitsvat maandusjuhti sisaldava vooluvarustusega. Maandamisvõimaluste ja jääkrikke kaitse loomine masinale tervikuna on seadmete tootja või paigaldaja kohustus.

Masina ohutus



HOIATUS: UCC T3 väljalülitamine või isoleerimine EI pruugi masina ootamatut liikumist ära hoida. Kasutajal soovitatakse isoleerida masin vooluvarustusest, suruõhust või teistest energiaallikatest masina tootja instruktsioonide kohaselt enne, kui sisenetakse ohutsooni või asutakse tegema hooldustoiminguid.

Kui seadet kasutatakse viisil, mida tootja ei ole ette näinud, võib seadme pakutav kaitse väheneda.

UCC T3 installation guide

www.renishaw.com

UCC T3 kontrolleri sisseehitatud hädaseiskamise turvasüsteem on mõeldud saavutama standardi BS EN ISO13849-1:2008 2. kategooriat, kuid selle riistvara on võimalik konfigurida ka B kategooria saavutamiseks. Seetõttu peaks süsteemi paigaldaja tehtud ohtude hindamine paigalduskohale tegema kindlaks, milline on vajalik kategooria.

UCC T3 võib kasutusse võtta ainult Renishaw tarkvara abil. Sellest mitte kinnipidamine võib tuua endaga kaasa masina ootamatu liikumise.

FI: Turvallisuuosutukset UCC T3-ohjaimelle

Ympäristöolosuhteet

Käyttö sisätiloissa	IP30* (BS EN60529:1992)
Korkeus maan pinnasta	enintään 2000 m
Käyttölämpötila	+5 °C... +50 °C
Varastointilämpötila	-25 °C... +70 °C
Suhteellinen kosteus	Enintään 80% (tiivistymätön) lämpötilaan +31 °C saakka Lineaarinen pieneneminen 50%:iin saakka lämpötilassa +40 °C
Siirtojännitteet	Installation category II
Saastumisaste	2

 **HUOMAA:** UCC T3 saattaa olla tarpeen koteloida sopivaan sähköasiaan asennuspaikan ympäristön olosuhteiden mukaan paremman IP-luokituksen saavuttamiseksi.

 **HUOMAA:** Kun ympäristön lämpötila on alle 40 °C, UCC T3-ohjaimen suurin syöttöteho on 800 W. Lämpötiloissa 40 °C ... 50 °C suurin teho on 400 W.

 **VAROITUS:** UCC T3-ohjainta ei suositella käytettävän yli 50 °C lämpötiloissa.

 **VAROITUS:** Koko koneen maadoituksen toteuttaminen on OEM-valmistajan tai asentajan vastuulla.

 **VAROITUS:** Eristys: UCC T3 eristetään tasavirtalähteestä irrottamalla virtaliitin. Jos muita eristämistapoja tarvitaan, ne tulee määritellä ja asentaa koneen valmistajan tai tuotteen asentajan toimesta. Eristyskytkin on sijoitettava standardin IEC61010 ja asennuspaikalla voimassa olevien sähköteknisten asennusohjeiden mukaisesti sellaiseen paikkaan, jossa se on helposti CMM-käyttäjän ulottuvilla.

 **VAROITUS:** PSU-yksikön tulee olla vikasetoimen, hyväksytty standardin EN60950-1 mukaisesti ja liitetty suojamaadoitusjohtimella varustettuun virtalähteeseen. Koko koneen maadoituksen ja muiden vikasuojauksen toteuttaminen on OEM-valmistajan tai asentajan vastuulla.

UCC T3 installation guide

www.renishaw.com

Koneen turvallisuus



VAROITUS: UCC T3-ohjaimen kytkeminen pois päältä tai eristäminen EI välttämättä estä odottamattomia koneen liikkeitä. Käyttäjää kehoitetaan eristämään kone sähkövirtalähteestä, paineilmalähteestä ja muista energialähteistä koneen valmistajan ohjeiden mukaisesti ennen kulkemista vaaralliselle alueelle tai huoltotehtävien suorittamista.

Jos laitetta käytetään valmistajan ohjeista poikkeavalla tavalla, sen suojavaikutus voi olla puutteellinen.

UCC T3-ohjaimen integroidut hätäpysäytysjärjestelmät ovat standardin BS EN ISO13849-1:2008 luokan 2 mukaisia, ja luokan B mukainen taso saavutetaan asianmukaisten laitekonfiguraatioiden avulla. Järjestelmän asentajan on tehtävä riskiarviointi asennuspaikalla ja määritettävä sen perusteella, mikä luokitus vaaditaan.

UCC T3-ohjaimen saa ottaa käyttöön vain Renishaw-ohjelmiston avulla, koska muussa tapauksessa voi seurauksena olla odottamattomia koneen liikkeitä.

FR: Recommandations de sécurité pour le contrôleur UCC T3

Conditions d'environnement

Utilisation intérieure	IP30* (BS EN60529:1992)
Altitude	Jusqu'à 2 000 m
Température d'utilisation	de +5 °C à +50 °C
Température de stockage	de -25 °C à +70 °C
Humidité relative	80% maximum (sans condensation) pour les températures jusqu'à +31 °C Réduction linéaire à 50% à +40 °C
Tensions transitoires	Installation category II
Degré de pollution	2



REMARQUE : Il peut être nécessaire de mettre l'UCC T3 dans une enceinte électrique adéquate suivant les conditions d'environnement de l'installation pour obtenir un niveau IP supérieur.



REMARQUE : Pour les températures ambiantes inférieures à 40 °C, la puissance d'alimentation maximale de l'UCC T3 est de 800 W. Pour des températures entre 40 °C et 50 °C, cette puissance est de 400 W.



ATTENTION : Il est déconseillé d'utiliser l'UCC T3 à des températures ambiantes supérieures à 50 °C.



ATTENTION : Il incombe à l'équipementier ou à l'installateur de prévoir une mise à la terre de toute la machine.

UCC T3 installation guide

www.renishaw.com



ATTENTION : Sectionnement : L'UCC T3 est coupé de l'alimentation c.c. par déconnexion du connecteur électrique. Si un moyen de sectionnement complémentaire est nécessaire, il doit être spécifié et installé par le constructeur de la machine ou l'installateur du produit. Ce sectionneur doit être facilement accessible par l'opérateur de la MMT et conforme à la norme IEC61010 ainsi qu'à toute réglementation de câblage applicable dans le pays d'installation.



ATTENTION : Le bloc d'alimentation doit avoir une tolérance à une panne, homologuée suivant EN60950-1, et doit être branché sur une alimentation intégrant un conducteur de terre. Il incombe à l'équipementier ou à l'installateur de prévoir une mise à la terre et une protection contre les pannes résiduelles de toute la machine.

Sécurité machine



ATTENTION : Mettre l'UCC T3 hors tension ou l'isoler N'EXCLUE PAS des mouvements inattendus de la machine. Il est conseillé à l'utilisateur d'isoler celle-ci des alimentations électrique, d'air comprimé et d'autres sources d'énergie conformément aux instructions du constructeur de la machine avant de pénétrer dans la zone de danger ou de réaliser des opérations de maintenance.

L'utilisation de cet équipement d'une manière non spécifiée par le constructeur peut compromettre la protection dont cet équipement est pourvu.

Le système de sécurité par arrêt d'urgence intégré au contrôleur UCC T3 est conçu suivant les critères de Catégorie 2 de la norme BS EN ISO13849-1 :2008 ; le matériel permet une configuration pour répondre à la Catégorie B. L'évaluation de risque effectuée par l'installateur lors de l'installation du système doit donc avoir déterminé la catégorie requise.

L'UCC T3 doit être mis en service exclusivement par un logiciel Renishaw car sans cela des mouvements inattendus de la machine pourraient avoir lieu.

GA: Moltaí sábháilteachta don rialaitheoir UCC T3

Dálaí timpeallachta

Úsáid laistigh	IP30* (BS EN60529:1992)
Airde	suas go 2000 m
Teocht oibriúcháin	+5 °C go +50 °C
Teocht stórála	-25 °C go +70 °C
Bogthaise choibhneasta	Uasmhéid 80% (neamh-chomhdhlúthú) do theochtaí suas go +31°C Laghdú líneach go 50% ag +40 °C
Voltais neamhbhuana	Installation category II
Méid truaillithe	2



NÓTA: D'fhéadfadh riachtanas bheith ann UCC T3 a fheireadh in iniamh leictreach oiriúnach de réir dálaí timpeallachta an fhearais chun rátáil IP níos airde a bhaint amach.

UCC T3 installation guide

www.renishaw.com



NÓTA: I dtaca le teochtaí timpeallacha faoi 40 °C, is é 800 W cumhacht ionchuir uasmhéid don UCC T3. Is é 400 W an chumhacht uasmhéid do theochtaí idir 40 °C agus 50 °C.



RABHADH: Níl UCC T3 molta le húsáid i dteochtaí timpeallacha níos airde ná 50 °C.



RABHADH: Tá an OEM nó an suiteálaí freagrach as soláthairtí talmhaithe don mheaisín iomlán.



RABHADH: Aonrú: Tá UCC T3 aonraithe ón soláthar cumhachta DC trí dhínascú den naschóir cumhachta. Má tá aon mhodhanna aonraithe breise riachtanach, ní mór do dhéantúsóir an mheaisín nó suiteálaí an tairge é a mhionsonrú agus a shuiteáil. Ní mór an t-aonraitheoir a shuiteáil cóngarach don oibritheoir CMM agus é i gcomhlíonadh le IEC61010 agus le haon rialacháin náisiúnta sreangaithe infheidhmithe don tír inar suiteáiltear é.



RABHADH: Ní mór an PSU bheith aon-lochtlamhálach, faofa chuig EN60950-1 agus é nasctha le soláthar ina bhfuil seoltóir talmhaithe cosanta. Tá an OEM nó an suiteálaí freagrach as soláthairtí talmhaithe agus cosaint lochta iarmharaigh don mheaisín iomlán.

Sábháilteacht mheaisín



RABHADH: Tá seans ann NACH gcoiscfear gluaiseacht an mheaisín gan choinne tríd an UCC T3 a mhúchadh nó a aonrú. Moltar don úsáideoir an meaisín a aonrú ón soláthar leictreachais, ó aer comhbhrúite nó ó fhoinsí fuinnimh eile de réir treoracha ó dhéantúsóra an mheaisín sula dtéitear isteach sa chrios guaise nó sula ndéantar aon oibriúcháin chothabhála.

Má úsáidtear an trealamh ar bhealach nach bhfuil mionsonraithe ag an déantúsóir, d'fhéadfadh an chosaint sa trealamh bheith lagaithe.

Tá an córas sábháilteachta stop éigeandála atá comhtháthaithe isteach sa rialaitheoir UCC T3 deartha le catagóir 2 a bhaint amach chuig caighdeán BS EN ISO 13849-1:2008, d'fhéadfadh é seo bheith mar earraí crua cumraithe chun catagóir B a bhaint amach. Dá bhrí sin, ba chóir go mbeadh an chatagóir atá riachtanach dearbhaithe ag an measúnú riosca a rinne suiteálaí an chórais ar an suiteáil.

Ní mór an UCC T3 bheith coimisiúnaithe trí bhogearraí Renishaw. Gan é seo a dhéanamh, d'fhéadfadh gluaiseacht an mheaisín gan choinne a tharlú.

HU: Biztonsági előírások az UCC T3 vezérlő számára

Környezeti feltételek

UCC T3 installation guide

www.renishaw.com

Beltéri használat	IP30* (BS EN60529:1992)
Tengerszint feletti magasság:	max. 2000 m
Üzemi hőmérséklet	+5 °C – +50 °C
Tárolási hőmérséklet	-25 °C – +70 °C
Relatív páratartalom	max 80%. (nem lecsapódó), legfeljebb +31 °C hőmérsékletig lineáris csökkenés 50%-ig +40°C hőmérsékleten
Átütési feszültség	Installation category II
Szennyeződés mértéke	2



MEGJEGYZÉS: Szükségessé válhat az UCC T3 megfelelő elektromos szekrényben elhelyezni a beszerelési környezet feltételeinek megfelelően azért, hogy magasabb IP védetségű értékek érjünk el.



MEGJEGYZÉS: 40 °C alatti környezeti hőmérséklet esetén az UCC T3 max 800 W teljesítményt vesz fel. 40 °C és 50 °C közötti hőmérséklet esetén a maximális felvett teljesítmény 400 W.



FIGYELMEZTETÉS: Az UCC T3 használata nem javasolt 50 °C feletti környezeti hőmérséklet esetén.



FIGYELMEZTETÉS: A teljes berendezés földeléséről a gyártónak vagy a telepítést végző szakembernek kell gondoskodnia.



FIGYELMEZTETÉS: Leválasztás: Az UCC T3 leválasztása az egyenáramú energiaforrásról a csatlakozó leválasztásával történik. Ha egyéb leválasztásra lenne szükség, akkor azt a berendezés gyártójának vagy a termék beszerelőjének kell meghatározni és beszerelnie. A leválasztónak a CMM üzemeltető számára könnyen hozzáférhető helyen kell lennie, és meg kell felelnie az IEC61010 szabványnak, illetve a területileg érvényes villamos bekötési szabályoknak.



FIGYELMEZTETÉS: A tápegységnek meg kell felelni az EN60950-1 szabvány előírásainak, és védőföldeléssel ellátott aljzathoz kell csatlakoztatni. A teljes berendezés földeléséről és a zavarvédelemről a gyártónak vagy a telepítést végző szakembernek kell gondoskodnia.

Gépbiztonság



FIGYELMEZTETÉS: Az UCC T3 kikapcsolása vagy leválasztása NEM feltétlenül akadályozza meg a berendezés váratlan mozgását. A felhasználónak le kell választania a berendezést az áramforrásról, sűrített levegőről és más energiaforrásokról a berendezés gyártói előírásainak megfelelően, mielőtt veszélyes területekre lépnének, illetve bármilyen karbantartási munkát végeznének.

A berendezés nem a gyártó által meghatározott módon történő használata befolyásolhatja a berendezés által nyújtott védelmet.

Az UCC T3 vezérlőbe integrált vészleállító biztonsági rendszer megfelel a BS EN ISO13849-1:2008 szabvány 2. kategóriájának; ez lehet a B

UCC T3 installation guide

www.renishaw.com

kategória eléréséhez konfigurált hardver. A rendszer telepítője által a telepítéskor végzett kockázatfelmérésnek ezért tartalmaznia kell, hogy mely kategóriára van szükség.

Az UCC T3 kizárólag Renishaw szoftverrel telepíthető, ellenkező esetben váratlan gépmozgások léphetnek fel.

IT: Raccomandazioni di sicurezza per il controllo UCC T3

Condizioni ambientali

Per uso interno	IP30* (BS EN60529:1992)
Altitudine	fino a 2000 m
Temperatura di funzionamento	da +5 °C a +50 °C
Temperatura di stoccaggio	da -25 °C a +70 °C
Umidità relativa:	80% massimo (senza condensa) per temperature fino a +31 °C Diminuzione lineare fino al 50% a +40 °C
Oscillazioni di tensione	Installation category II
Grado di inquinamento	2



NOTA: Per ottenere una classificazione IP più elevata, potrebbe essere necessario alloggiare il controllo UCC T3 in un armadietto elettrico adeguato alle condizioni ambientali di installazione.



NOTA: In caso di temperature ambientali inferiori a 40 °C, la potenza massima di ingresso di UCC T3 è 800 W. Se la temperatura è compresa fra 40 °C e 50 °C la potenza massima è 400 W.



AVVERTENZA: Si sconsiglia l'utilizzo del controllo UCC T3 in ambienti con temperature superiori a 50 °C.



AVVERTENZA: La responsabilità di eseguire la messa a terra dell'intera macchina è a carico dell'OEM o dell'installatore.



AVVERTENZA: Isolamento: Per isolare elettricamente il controllo UCC T3, scollegare il connettore di alimentazione. Nel caso in cui fossero necessari ulteriori dispositivi di isolamento, sarà necessario specificare tale esigenza e richiedere al produttore della macchina o all'installatore di provvedere in tale senso. Il dispositivo di isolamento dovrà essere posizionato in un punto facilmente accessibile all'operatore della macchina CMM e dovrà risultare conforme allo standard IEC61010 e a tutte le normative nazionali sui cablaggi in vigore nel paese di installazione.



AVVERTENZA: L'alimentatore PSU deve essere conforme alla norma EN60950-1 e collegato a una sorgente di alimentazione dotata di un sistema di protezione con conduttore di messa a terra. La responsabilità di eseguire la messa a terra del sistema e delle misure di protezione per l'intera macchina è a carico dell'OEM o dell'installatore.

UCC T3 installation guide

www.renishaw.com

Sicurezza della macchina



AVVERTENZA: Lo spegnimento del controllo UCC T3 o la disconnessione dall'alimentazione NON garantisce che non possano esservi spostamenti imprevisti della macchina. Prima di accedere alla zona di pericolo o di eseguire operazioni di manutenzione, si consiglia di scollegare la macchina, oltre che dall'alimentazione elettrica, anche dall'aria compressa o da altre fonti di energia, in conformità alle istruzioni del produttore.

Se utilizzato in modo non conforme a quanto specificato dal produttore, il dispositivo potrebbe non fornire il livello di protezione previsto.

Il sistema di arresto di emergenza integrato nel controllo UCC T3 è stato progettato per conformarsi alla categoria 2 dello standard BS EN ISO13849-1:2008 e può essere configurato tramite hardware per ottenere la categoria B. La valutazione di rischio, effettuata al momento dell'installazione, da parte del tecnico incaricato determinerà quale sia la categoria richiesta.

La messa in funzione del controllo UCC T3 deve avvenire solo tramite il software Renishaw. In caso contrario la macchina potrebbe non funzionare o generare spostamenti imprevisti.

LT: „UCC T3“ valdiklio saugos rekomendacijos

Aplinkos sąlygos

Naudoti patalpoje	IP30* (BS EN60529:1992)
Aukštis virš jūros lygio	iki 2 000 m
Darbinė temperatūra	nuo +5 °C iki +50 °C
Laikymo temperatūra	nuo -25 °C iki +70 °C
Santykinis oro drėgnis	Daugiausia 80% (nesikondensuojantis), esant temperatūrai iki +31 °C Linijinis mažėjimas iki 50%, esant +40 °C
Pereinamoji įtampa	Installation category II
Užterštumo laipsnis	2



PASTABA: siekiant išgauti aukštesnius IP parametrus, atsižvelgus į montavimo aplinkos sąlygas, „UCC T3“ gali reikėti patalpinti į tinkamą elektrinį įdėklą.



PASTABA: kai aplinkos temperatūra nesiekia 40 °C, „UCC T3“ maksimali tiekiamą galia yra 800 vatų. Esant 40 °C – 50 °C temperatūrai, maksimali galia yra 400 vatų.



ĮSPĖJIMAS: nerekomenduojama naudoti „UCC T3“, kai aplinkos temperatūra viršija 50 °C.



ĮSPĖJIMAS: atsakomybė dėl viso įrenginio žeminimo tenka originalios įrangos gamintojui arba montuotojui.

UCC T3 installation guide

www.renishaw.com



ĪSPĒJIMAS: izoliavimas: atjungus maitinimo jungtj, „UCC T3” yra izoliuotas nuo pastoviosios srovės maitinimo. Jei reikia papildomų izoliavimo priemonių, jas turi nurodyti ir sumontuoti įrenginio gamintojas arba produkto montuotojas. Skyriklis turi būti lengvai pasiekiamas koordinatinės matavimo mašinos operatoriui ir turi atitikti IEC61010 bei kitas valstybės, kurioje montuojama mašina, elektros laidų instaliacijos taisykles.



ĪSPĒJIMAS: galios tiekimo įrenginys turi būti atsparus gedimams, patvirtintas pagal EN60950-1 ir prijungtas prie maitinimo tinklo, panaudojant apsauginį žeminimo laidininką. Atsakomybė dėl viso įrenginio žeminimo ir liekamosios apsaugos nuo gedimų tenka originalios įrangos gamintojui arba montuotojui.

Įrenginio sauga



ĪSPĒJIMAS: išjungus arba izoliavus „UCC T3”, gali NEPAVYKTI išvengti netikėto įrenginio pajudėjimo. Naudotojui patariama pagal įrenginio gamintojo nurodymus izoliuoti įrenginį nuo elektros tinklo, suspausto oro arba kitų energijos šaltinių, paskui galima saugiai patekti į pavojaus zoną arba atlikti bet kokius techninės priežiūros darbus.

Jei įranga naudojama ne taip, kaip nurodo gamintojas, gali sumažėti įrangos teikiama apsauga.

„UCC T3” valdiklyje integruota avarinio sustabdymo saugos sistema pagal BS EN ISO 13849-1:2008 yra 2 kategorijos, tačiau panaudojus techninę įrangą, ji gali būti sukonfigūruota kaip atitinkanti B kategoriją. Todėl sistemos montuotojo atliekamam įrangos rizikos vertinimu turi būti nustatoma, kuri kategorija yra reikalinga.

„UCC T3” derinkite tik naudodami „Renishaw” programinę įrangą; nesilaikant šio nurodymo, įrenginys gali netikėtai pajudėti.

LV: Drošības ieteikumi „UCC T3” vadāmīerīcei

Apkārtējās vides nosacījumi

Lietošana telpās	IP30* (BS EN60529:1992)
Augstums	līdz 2000 m
Darbības temperatūra	no +5 °C līdz +50 °C
Uzglabāšanas temperatūra	no -25 °C līdz +70 °C
Relatīvais mitrums	maksimums 80% (bez kondensēšanās) temperatūrā līdz +31 °C Lineārais samazinājums +40 °C temperatūrā līdz 50%
Nestacionārais spriegums	Installation category II
Piesārņojuma pakāpe	2



PIEZĪME: lai iegūtu augstāku ierīces IP (starptautisko aizsardzības) novērtējumu atkarībā no uzstādīšanas vides nosacījumiem, iespējams, ka „UCC T3” ir nepieciešams ievietot piemērotā elektriski izolējošā apvalkā.

UCC T3 installation guide

www.renishaw.com



PIEZĪME: izmantojot temperatūrā, kas zemāka par +40 °C, maksimālā pievadāmā elektroenerģijas jauda ir 800 W. Ja temperatūra ir no +40 °C līdz +50 °C, maksimālā jauda ir 400 W.



BRĪDINĀJUMS: nav ieteicams izmantot „UCC T3”, ja apkārtējā temperatūra pārsniedz +50 °C.



BRĪDINĀJUMS: par pareizu visas ierīces zemēšanu ir atbildīgs tās ražotājs vai uzstādītājs.



BRĪDINĀJUMS: atvienošana: „UCC T3” no līdzstrāvas padeves iespējams atvienot, izmantojot strāvas savienotāju. Ja vajadzīgi papildu atvienošanas līdzekļi, tie ir jānorāda un jānodrošina ierīces ražotājam vai izstrādājuma uzstādītājam. Atvienotājam jābūt novietotam tā, lai tas būtu viegli pieejams CMM operatoram un atbilstu IEC61010 un jebkuriem saistītajiem uzstādīšanas valsts elektrotehniskajiem noteikumiem.



BRĪDINĀJUMS: nepārtrauktās barošanas avotam jābūt bojājumpieciešīgam, jāatbilst EN60950-1 standartam un jābūt pievienotam strāvas padevei ar aizsargājošu zemējuma vadu. Par pareizu visas ierīces zemēšanu un pārējās pretklūmjū aizsardzības uzstādīšanu ir atbildīgs tās ražotājs vai uzstādītājs.

Ierīces drošība



BRĪDINĀJUMS: „UCC T3” izslēgšana vai atvienošana NEGARANTĒ to, ka ierīce neuzsāks neparedzētu darbību. Pirms iet paaugstinātās bīstamības zonā vai uzsākt apkopes darbus, lietotājam ieteicams saskaņā ar ražotāja instrukcijām atvienot ierīci no strāvas padeves, saspiesta gaisa vai citiem enerģijas avotiem.

Ja izstrādājums tiek lietots veidā, kas neatbilst ražotāja norādītajam, ierīces nodrošinātā aizsardzība var mazināties.

„UCC T3” vadāmīerīcē iebūvētā avārijas apturēšanas sistēma izstrādāta, lai atbilstu BS EN ISO13849-1:2008 standarta 2. kategorijai, un to iespējams pārveidot, lai atbilstu B kategorijas nosacījumiem. Sistēmas uzstādītājam jāveic riska novērtējums, lai noteiktu, kura drošības kategorija ir nepieciešama.

„UCC T3” drīkst pārvaldīt, izmantojot tikai „Renishaw” programmatūru, jo pretējā gadījumā tas var izraisīt ierīces neparedzētu darbību.

MT: Rakkomandazzjonijiet dwar is-sigurtàġhall-UCC T3 controller

Kundizzjonijiet ambjentali

UCC T3 installation guide

www.renishaw.com

Użu fuq ġewwa	IP30* (BS EN60529:1992)
Altitudni	sa 2000 m
Temperatura tal-operat	5 °C sa +50 °C
Temperatura li fiha jista' jinħażen	-25 °C sa +70 °C
Umditàrelattiva	Massimu ta' 80% (bla kondensazzjoni) għal temperaturi sa +31 °C Tnaqqis lineari għal 50% f'temperaturata' +40 °C
Vultaġġi temporanji	Installation category II
Grad ta' tniġġiz	2

 **NOTA:** Jista' jkun hemm bżonn li tpoġġi l-UCC T3 ġo kompartiment elettriku adattat skont il-kundizzjonijiet ambjentali tal-installazzjoni biex tikseb IP rating ogħla.

 **NOTA:** Għal temperaturi ambjentali taħt l-40 °C, il-provvista massima tad-dawl tal-input għall-UCC T3 hi ta' 800 W. Temperaturi bejn l-40°C u l-50 °C, il-provvista massima tad-dawl hi ta' 400 W.

 **TWISSIJA:** UCC T3 mhuwiex rakkomandat għall-użu f'temperaturi ambjentali ogħla minn 50 °C.

 **TWISSIJA:** Il-provvedimenti tal-earthing għall-magna sfiha huma r-responsabbiltà tal-OEM jew tal-installatur.

 **TWISSIJA:** Izolament: L-UCC T3 jiġi iżolat mill-provvista tad-dawl DC billi tiskonnettja l-konnettur tal-provvista tad-dawl. Jekk ikun hemm bżonn ta' mezz addizzjonali ta' iżolament, dawn iridu jiġu speċifikati u jiġu mmuntati mill-operatur tal-magna jew mill-installatur tal-prodott. L-iżolatur irid jitpoġġa fejn ikun jista' jintlaħaq faċilment mill-operatur tas-CMM u jrid ikun konformi ma' IEC61010 u ma' kwalunkwe regolamenti nazzjonali applikabbli dwar il-wiring għall-pajjiż fejn ikun qed jiġi installat.

 **TWISSIJA:** Il-PSU jrid jittollera ħsara waħda, ikun approvat skont EN60950-1 u jrid jitqabbd ma' provvista tad-dawl li tinkorpora konduttur protettiv tal-earth. Il-provvedimenti tal-earthing u l-protezzjoni minn ħsara residwa għall-magna sfiha huma r-responsabbiltà tal-OEM jew tal-installatur.

Sigurtà tal-magna

 **TWISSIJA:** Li titfi jew li tizola l-UCC T3 jista' MA JIPPREVENIX moviment mhux mistenni tal-magna. Hu rakkomandat li l-utent jizola l-magna mill-provvista tad-dawl, minn arja kkompressata jew minn sorsi oħrajn ta' enerġija skont l-istruzzjonijiet tal-manifattur tal-magna qabel ma jidhol fiż-żona ta' periklu jew qabel ma jwettaq kwalunkwe xogħol ta' manutenzjoni.

Jekk it-tagħmir jintuza b'mod li ma jkunx speċifikat mill-manifattur, il-protezzjoni pprovduta mit-tagħmir tista' titnaqqas.

Is-sistema tas-sigurtà ta' waqfien ta' emergenza li ġiet integrata fil-kontrollur tal-UCC T3 hi maħsuba biex tilhaq kategorija 2 għal standard BS

UCC T3 installation guide

www.renishaw.com

EN ISO13849-1:2008; din tista' tigi kkonfigurata permezz tal-hardware biex tinthalaq kategorija B. Għalhekk, l-evalwazzjoni tar-riskju li tkun saret mill-installatur tas-sistema fuq l-installazzjoni, suppost li tkun stabbilixxiet liema kategorija hi meħtieġa.

L-UCC T3 irid jiġi kkommissjonat biss permezz tar-Renishaw software. Jekk tonqos li tagħmel dan, dan jista' jirriżulta f'moviment mhux mistenni tal-magna.

NL: Veiligheidsaanbevelingen voor de besturing UCC T3

Omgevingscondities

Gebruik binnenshuis	IP30* (BS EN60529:1992)
Hoogte	Tot 2000 m
Omgevingstemperatuur	+5 °C tot +50 °C
Opslagtemperatuur	-25 °C tot +70 °C
Relatieve vochtigheid	Maximaal 80% (geen condensatie) voor temperaturen tot +31 °C Lineaire afname tot 50% bij +40 °C
Piekspanningen	Installation category II
Verontreinigingsgraad	2



OPMERKING: Het kan nodig zijn om de UCC T3 in een passende behuizing onder te brengen die bij de omgevingscondities past, om een hogere IP-waarde te verkrijgen.



OPMERKING: Voor gebruikstemperaturen onder de 40 °C is het maximale ingangsvermogen van de UCC T3 800 W. Bij temperaturen tussen 40 °C en 50 °C bedraagt het maximale vermogen 400 W.



WAARSCHUWING: De UCC T3 wordt niet aanbevolen voor toepassing bij gebruikstemperaturen boven 50 °C.



WAARSCHUWING: Voor aardingsvoorzieningen voor de gehele machine is de OEM of installateur verantwoordelijk.



WAARSCHUWING: Afsluiten: De UCC T3 wordt van de gelijkstroombron afgesloten door de spanningsconnector te ontkoppelen. Als nog een extra manier van afsluiten gevraagd wordt, dan moet die gespecificeerd en geplaatst worden door de machinefabrikant of de monteur van het product. De afsluitvoorziening moet ruim binnen het bereik van de CMM-operator aangebracht worden en voldoen aan IEC61010 en de andere elektrische regels die gelden in het land van plaatsing.



WAARSCHUWING: De voedingseenheid moet enkele-fouttolerant zijn, goedgekeurd zijn volgens EN60950-1 en worden aangesloten op een stroombron met een aardverbinding ter beveiliging. Aardingsvoorzieningen en beveiliging tegen resterende fouten voor de gehele machine zijn de verantwoordelijkheid van de OEM of installateur.

UCC T3 installation guide

www.renishaw.com

Machineveiligheid



WAARSCHUWING: De UCC T3 uitschakelen of afsluiten is GEEN garantie tegen onverwachte machinebewegingen. De gebruiker wordt geadviseerd om de machine volgens de instructies van de machinefabrikant af te sluiten van de voedingsspanning, perslucht en andere energiebronnen, en pas daarna gevaarlijke gebieden te betreden of onderhoud te verrichten.

Gebruik van de apparatuur op een manier die de fabrikant niet voorgeschreven heeft, kan het apparaat beschadigen of de bescherming beperken.

Het veiligheidssysteem met noodstop dat ingebouwd is in de besturing UCC T3, is afgestemd op realisatie van categorie 2 volgens norm BS EN ISO13849-1:2008. Via hardwareconfiguratie is dit te veranderen in categorie B. De risicobeoordeling door degene die het systeem installeert moet daarom aangeven welke categorie vereist is.

De UCC T3 mag alleen in bedrijf gesteld worden met behulp van Renishaw software, anders kunnen zich onverwachte machinebewegingen voordoen.

PL: Zalecenia dotyczące bezpieczeństwa dla sterownika UCC T3

Warunki środowiskowe

Urządzenie przeznaczone do użytkowania w pomieszczeniach	Stopień ochrony IP30* (BS EN60529:1992)
Wysokość nad poziomem morza	do 2000 m
Temperatura pracy	od +5 °C do +50 °C
Temperatura przechowywania	od -25 °C do +70 °C
Wilgotność względna	maksymalnie 80% (bez kondensacji pary wodnej) w temperaturach do +31 °C liniowy spadek do 50% w temperaturze +40 °C
Napięcie przejściowe	Installation category II
Stopień skażenia	2



UWAGA: W celu osiągnięcia wyższego stopnia ochrony, konieczne może być umieszczenie sterownika UCC T3 w odpowiedniej obudowie elektrycznej, zgodnie z warunkami środowiskowymi instalacji.



UWAGA: Przy temperaturze otoczenia niższej niż 40 °C, maksymalna moc wejściowa dla sterownika UCC T3 wynosi 800 W. Przy temperaturach pomiędzy 40 °C a 50 °C, maksymalna moc wejściowa wynosi 400 W.



OSTRZEŻENIE: Nie zaleca się używania sterownika UCC T3 w temperaturze otoczenia powyżej 50 °C.



OSTRZEŻENIE: Za zapewnienie warunków uziemienia całej maszyny jest odpowiedzialny producent maszyny lub instalator.

UCC T3 installation guide

www.renishaw.com



OSTRZEŻENIE: Izolacja: Sterownik UCC T3 jest izolowany od zasilania prądem stałym poprzez odłączenie złącza zasilania. Gdy wymagane są jakiegokolwiek dodatkowe środki odłączania, ich dane techniczne muszą być określone i muszą one być zainstalowane przez producenta maszyny lub instalatora produktu. Odłącznik musi być umieszczony w taki sposób, aby zapewniać operatorowi maszyny współrzędnościowej łatwy dostęp do niego oraz musi spełniać wymagania IEC61010 i wszelkich przepisów dotyczących okablowania, jakie obowiązują w kraju instalacji.



OSTRZEŻENIE: Zasilacz powinien tolerować tylko "jedną usterkę", jak określono w normie EN60950-1 i musi być podłączony do zasilania wyposażonego w przewód uziemienia ochronnego. Zapewnienie warunków uziemienia oraz ochrona przed ryzykiem resztkowym całej maszyny są odpowiedzialnością producenta sprzętu oryginalnego lub instalatora.

Bezpieczeństwo maszyny



OSTRZEŻENIE: Wyłączenie lub odizolowanie sterownika UCC T3 może NIE zapobiec nieoczekiwanym ruchom maszyny. Zaleca się, aby przed wejściem do strefy niebezpiecznej lub wykonaniem jakichkolwiek czynności konserwacyjnych użytkownik odizolował maszynę od zasilania prądem elektrycznym, sprężonym powietrzem bądź od innych źródeł energii, zgodnie z zaleceniami producenta maszyny.

Jeżeli wyposażenie jest użytkowane w inny sposób niż określił to producent, zabezpieczenie zapewniane przez to wyposażenie może być osłabione.

Połączony ze sterownikiem UCC T3, system awaryjnego zatrzymania został zaprojektowany aby osiągnąć kategorię 2, zgodnie z normą BS EN ISO13849-1:2008, co można skonfigurować sprzętowo aby osiągnąć kategorię B. Ocena ryzyka wykonana przez instalatora systemu podczas instalacji powinna więc określać, która kategoria jest wymagana.

Sterownik UCC T3 powinien być uruchomiony tylko poprzez oprogramowanie firmy Renishaw. Niezastosowanie się do tego zalecenia może spowodować nieoczekiwany ruch maszyny.

PT: Recomendações de segurança para o comando UCC T3

Condições ambientais

Uso interno	IP30* (BS EN60529:1992)
Altitude	até 2000 m
Temperatura operacional	+5 °C a +50 °C
Temperatura de armazenamento	-25 °C a +70 °C
Umidade relativa	80% máximo (sem condensação) para temperaturas até +31 °C Redução linear até 50% a +40 °C
Tensões transientes	Installation category II
Grau de poluição	2

UCC T3 installation guide

www.renishaw.com



NOTA: Pode ser necessário alojar o UCC T3 em um invólucro elétrico apropriado, de acordo com as condições ambientais da instalação, para obter um grau de proteção IP mais alto.



NOTA: Para temperaturas ambiente abaixo de 40 °C, máxima potência de entrada para o UCC T3 é 800 W. Para temperaturas entre 40 °C e 50 °C a potência máxima é 400 W.



ATENÇÃO: O UCC T3 não é recomendado para uso em temperaturas ambiente acima de 50 °C.



ATENÇÃO: O aterramento da máquina completa é de responsabilidade do OEM ou instalador.



ATENÇÃO: Isolamento: O UCC T3 é isolado da alimentação DC através da desconexão do conector de potência. Se qualquer outro meio de isolamento for necessário, o mesmo deverá ser especificado e preparado pelo fabricante da máquina ou instalador do produto. O isolador deve ser de fácil acesso para o operador da MMC e atender à norma IEC61010 e todas as demais regulamentações elétricas nacionais do país onde estiver instalado.



ATENÇÃO: A unidade de alimentação deve ser tolerante a falha singular, aprovada conforme EN60950-1 e ser conectada a uma alimentação que incorpore um condutor terra. O aterramento e a proteção contra falha residual da máquina completa são de responsabilidade do OEM ou instalador.

Segurança da máquina



ATENÇÃO: O desligamento ou o isolamento do UCC T3 pode NÃO impedir um movimento inesperado da máquina. Antes de entrar na zona de perigo ou executar trabalhos de manutenção, recomendamos que o usuário isole a máquina da alimentação elétrica, ar comprimido ou outras fontes de energia, de acordo com as instruções do fabricante.

Se o equipamento for utilizado de modo não especificado pelo fabricante, a proteção oferecida poderá ser prejudicada.

O sistema de segurança de parada de emergência que foi integrado ao comando UCC T3 é projetado para atingir a categoria 2 da norma BS EN ISO13849-1:2008, que pode ser configurado no hardware para obter a categoria B. A avaliação de risco realizada pelo instalador do sistema na instalação deve, portanto, ter determinado qual categoria é necessária.

O UCC T3 somente deve ser colocado em funcionamento através do software Renishaw. Se isto não for observado, podem ocorrer movimentos inesperados da máquina.

RO: Recomandări de siguranță pentru controller-ul UCC T3

Condiții de funcționare

UCC T3 installation guide

www.renishaw.com

Utilizare numai la interior	IP30* (BS EN60529:1992)
Altitudine	până la 2000 m
Temperatura de funcționare	De la +5 °C la +50 °C
Temperatura de depozitare	De la -25 °C la +70 °C
Umiditate relativă	Maxim 80% (fără condensare) pentru temperaturi până la +31 °C Scădere liniară până la 50% la +40 °C
Tensiuni tranzitorii	Installation category II
Grad de poluare	2

 **NOTĂ:** Pentru a ridica gradul de izolație IP poate fi necesară închiderea controller-ului UCC T3 într-o încălț suplimentară, în funcție de condițiile de mediu din punctul de instalare.

 **NOTĂ:** Pentru temperaturi sub 40 °C, puterea maximă de intrare a controller-ului UCC-T3 este de 800 W. Pentru temperaturi între 40 °C și 50 °C puterea maximă este 400 W.

 **ATENȚIE:** Nu se recomandă utilizarea UCC T3 la temperaturi mai mari de 50 °C.

 **ATENȚIE:** Împământarea întregii mașini este responsabilitatea OEM sau a instalatorului.

 **ATENȚIE:** Izolație: UCC T3 se poate izola de sursele de tensiune continuă prin decuplarea conectorului de alimentare. Dacă sunt necesare nivele suplimentare de izolație, acestea trebuie specificate și instalate de către producătorul sau instalatorul mașinii. Comanda izolației trebuie poziționată la îndemâna operatorului și trebuie să fie conformă cu IEC61010 și cu normele naționale aplicabile în țara de instalare.

 **ATENȚIE:** Sursa de energie electrică trebuie să permită o singură cădere (siguranță), conform cu EN60950-1 și trebuie să aibă împământare. Realizarea împământărilor și protecția la tensiuni reziduale pentru întreaga mașină este responsabilitatea OEM sau a instalatorului.

Recomandări de siguranță

 **ATENȚIE:** Oprirea sau izolarea controller-ului UCC T3 NU împiedică mișcările neprevăzute ale mașinii. Utilizatorul i se recomandă deconectarea mașinii de la sursa de energie electrică, sursa de aer comprimat și alte surse de energie, în conformitate cu instrucțiunile producătorului, înainte de a pătrunde în zona periculoasă sau de a efectua orice lucrări de întreținere.

Dacă echipamentul este utilizat într-o manieră nespecificată de producător, protecția oferită de echipament poate fi diminuată.

Sistemul de oprire de urgență integrat în UCC T3 este proiectat să se încadreze în categoria 2 a standardului BS EN ISO13849-1:2008 și poate

UCC T3 installation guide

www.renishaw.com

fi configurat hardware pentru a obține categoria B. Evaluarea riscurilor efectuată de către instalatorul sistemului la instalare trebuie să determine ce categorie este necesară.

UCC T3 trebuie comandat numai prin intermediul software-ului Renishaw, nerespectarea acestei condiții putând duce la miscări neprevăzute ale mașinii.

SK: Bezpečnostné odporúčania pre riadiacu jednotku UCC T3

Podmienky okolitého prostredia

Použitie v interiéri	IP30* (BS EN60529:1992)
Nadmorská výška	do 2000 m
Prevádzková teplota	+5 °C až +50 °C
Skladovacia teplota	-25 °C až +70 °C
Relatívna vlhkosť	Maximálne 80% (bez kondenzácie) pre teploty do +31 °C Lineárny pokles na 50% pri +40 °C
Prechodné napätia	Installation category II
Stupeň znečistenia	2

 **POZNÁMKA:** Jednotku UCC T3 môže byť potrebné umiestniť do vhodnej elektrickej skrinky podľa podmienok okolitého prostredia danej inštalácie, aby sa dosiahlo vyššie krytie IP.

 **POZNÁMKA:** Pre okolité teploty do 40 °C je maximálny príkon jednotky UCC T3 800 W. Pre teploty od 40 °C do 50 °C je maximálny príkon 400 W.

 **VÝSTRAHA:** Jednotku UCC T3 sa neodporúča používať pri okolitých teplotách nad 50 °C.

 **VÝSTRAHA:** Uzemnenie celého prístroja je zodpovednosťou pôvodného výrobcu zariadenia (OEM) alebo firmy vykonávajúcej inštaláciu.

 **VÝSTRAHA:** Izolácia: Jednotka UCC T3 je izolovaná od jednosmerného napájacieho zdroja odpojením napájacieho konektora. Ak sa vyžadujú akékoľvek ďalšie spôsoby izolácie, musí ich špecifikovať a nainštalovať výrobca prístroja alebo firma vykonávajúca inštaláciu výrobu. Izolátor musí byť umiestnený tak, aby bol ľahko dostupný pre operátora súradnicového meracieho prístroja (CMM) a musí spĺňať normu IEC61010 a všetky príslušné národné predpisy týkajúce sa káblových rozvodov platné v krajine inštalácie.

 **VÝSTRAHA:** Jednotka napájacieho zdroja musí byť odolná voči jednej poruche, schválená podľa normy EN60950–1 a musí byť pripojená k napájaniu s ochranným uzemňovacím vodičom. Uzemnenie celého prístroja a jeho ochrana prúdovým chráničom je zodpovednosťou pôvodného výrobcu zariadenia (OEM) alebo firmy vykonávajúcej inštaláciu.

UCC T3 installation guide

www.renishaw.com

Bezpečnosť prístroja



VÝSTRAHA: Vypnutie alebo izolácia jednotky UCC T3 NEMUSÍ zabrániť neočakávanému pohybu prístroja. Pred vstupom do nebezpečnej zóny alebo pred vykonaním ľubovoľných údržbových postupov sa používateľovi odporúča izolovať prístroj od zdroja elektrickej energie, stlačeného vzduchu alebo iných zdrojov energie v súlade s pokynmi výrobcu prístroja.

Ak sa zariadenie používa spôsobom, ktorý nešpecifikoval výrobca, môže to negatívne ovplyvniť ochranu poskytovanú zariadením.

Bezpečnostný systém núdzového vypnutia, ktorý bol integrovaný do riadiacej jednotky UCC T3, je navrhnutý tak, aby spĺňal kategóriu 2 podľa normy BS EN ISO13849-1:2008. Môže byť hardvérový nakonfigurovaný tak, aby spĺňal kategóriu B. Vyhodnotenie rizika firmou vykonávajúcou príslušnú inštaláciu systému preto musí zahŕňať určenie toho, ktorá kategória sa vyžaduje.

Jednotka UCC T3 sa smie uvádzať do prevádzky iba prostredníctvom softvéru od spoločnosti Renishaw, inak to môže spôsobiť neočakávaný pohyb prístroja.

SL: Varnostna priporočila za krmilnik UCC T3

Okoljski pogoji

Uporaba v zaprtih prostorih	IP30* (BS EN60529:1992)
Nadmorska višina	do 2000 m
Delovna temperatura	+5 °C do +50 °C
Temperatura skladiščenja	-25 °C do +70 °C
Relativna vlažnost	Največ 80% (brez kondenzacije) za temperature do +31 °C Linearno zmanjšanje do 50% pri +40 °C
Prehodne napetosti	Installation category II
Prehodne napetosti	2



OPOMBA: Ohišje naprave UCC T3 je morda treba spraviti v primerno električno omarico v skladu z okoljskimi pogoji inštalacije, s čimer naprava dobi višjo stopnjo zaščite IP.



OPOMBA: Maksimalna vhodna moč naprave UCC T3 pri temperaturah okolice pod 40 °C je 800 W. Maksimalna moč pri temperaturah med 40 °C in 50 °C je 400 W.



OPOZORILO: Uporaba naprave UCC T3 ni priporočljiva pri temperaturah okolice nad 50 °C.



OPOZORILO: Ozemljitev celotnega stroja je odgovornost proizvajalca originalne opreme ali inštalaterja.

UCC T3 installation guide

www.renishaw.com



OPOZORILO: Izolacija: UCC T3 se od enosmernega električnega napajanja loči z odklopom električnega priključka. Če so potrebna dodatna sredstva za ločevanje, jih mora določiti in vgraditi proizvajalec stroja oz. tisti, ki je izdelek inštaliral. Ločilno sredstvo mora biti nameščeno v doseg operatorja KMS in mora biti skladno s standardom IEC61010 ter z vsemi veljavnimi državnimi predpisi o električnih napeljavah v državi inštalacije.



OPOZORILO: Napajalnik mora biti toleranten na posamične napake, skladen z EN60950-1 in priključen na električno omrežje z vodnikom zaščitne ozemljitve. Ozemljitev in zaščita pred okvarnim tokom celotnega stroja je odgovornost proizvajalca originalne opreme ali inštalaterja.

Varnost stroja



OPOZORILO: Izklop ali ločitev naprave UCC T3 NE more zanesljivo preprečiti nepričakovanih gibanj stroja. Uporabniku priporočamo, naj loči stroj od virov električnega napajanja, stisnjene zraka in drugih virov energije v skladu z navodili proizvajalca stroja, preden vstopi v nevarno območje ali se loti vzdrževalnih del.

Drugačna uporaba opreme, kot jo je predpisal proizvajalec, lahko povzroči izpad zaščitnih funkcij opreme.

Varnostni sistem za zaustavitev v sili, ki je integriran v krmilnik UCC T3, je zasnovan za kategorijo 2 po standardu standard BS EN ISO13849-1:2008, in ga je mogoče hardversko konfigurirati za kategorijo B. Katera kategorija je potrebna, se določi z oceno tveganj, ki jo izdelava inštalater sistema za vsak primer posebej.

Krmilnik UCC T3 je dovoljeno zagnati samo s programsko opremo Renishaw, v nasprotnem primeru lahko pride do nepričakovanih gibanj stroja.

SV: Säkerhetsrekommendationer för styrenheten UCC T3

Miljöförhållanden

Inomhusanvändning	IP30* (SS-EN60529:1992)
Altitud	upp till 2 000 m
Driftstemperatur	+5 °C till +50 °C
Förvaringstemperatur	-25 °C till +70 °C
Relativ fuktighet	Högst 80% (ingen kondens) för temperaturer upp till +31 °C Linjär minskning till 50% vid +40 °C
Transientspänningar	Installation category II
Utsläppsgrad	2



OBS: Det kan vara nödvändigt att bygga in UCC T3 i en lämplig elektrisk kapsling i enlighet med installationens miljöförhållanden, för att nå ett högre IP-värde.

UCC T3 installation guide

www.renishaw.com



OBS: För omgivningstemperaturer under 40 °C är den maximala ineffekten 800 W för UCC T3. Vid temperaturer mellan 40 °C och 50 °C är den maximala effekten 400 W.



WARNING: UCC T3 rekommenderas inte för användning i omgivningstemperaturer över 50 °C.



WARNING: Hela maskinen måste jordas – detta ansvar åligger återförsäljaren eller installatören.



WARNING: Bryta strömmen: UCC T3 avskiljs från likströmsmatningen genom att dra ur kontakten. Om andra metoder behövs för att bryta strömmen måste maskintillverkaren eller installatören specificera och montera dessa. Brytaren måste sitta så att CMM-operatören enkelt kan komma åt den. Den ska följa IEC61010 och andra tillämpliga regler för elinstallation i det land där installationen sker.



WARNING: Nätenheten (PSU) måste kunna stå emot enkla fel, vara godkänd enligt SS-EN60950-1 och måste vara ansluten till en matning som har skyddsjordledare. Hela maskinen måste jordas och jordfelsbrytare installeras – detta ansvar åligger återförsäljaren eller installatören.

Maskinsäkerhet



WARNING: Även om UCC T3 stängs av eller kopplas från så kan ÄNDÅ oväntade maskinrörelser uppstå. Användaren rekommenderas att bryta strömmen, tryckluften och andra energikällor till maskinen, i enlighet med maskintillverkarens anvisningar innan någon person går in i riskzonen eller utför något underhåll.

Om utrustningen används på ett sätt som inte tillverkaren har avsett kanske skyddet fungerar sämre.

Nödstopps-/säkerhetssystemet som har integrerats i styrenheten för UCC T3 är konstruerad för att uppfylla kategori 2 enligt standarden SS-EN ISO13849-1:2008. Detta kan konfigureras med maskinvara för att uppnå kategori B. Den riskutvärdering som systeminstallatören gjort för installationen ska därför ha fastställt vilken kategori som krävs.

UCC T3 får endast tas i drift med programvara från Renishaw – om detta inte efterföljs kan oväntade maskinrörelser inträffa.

Renishaw plc
New Mills, Wotton-under-Edge,
Gloucestershire, GL12 8JR
United Kingdom

T +44 (0)1453 524524
F +44 (0)1453 524901
www.renishaw.com/cmmsupport

RENISHAW 
apply innovation™

**For worldwide contact details,
please visit our main website at
www.renishaw.com/contact**